

Practical Basic NVIS Antennas: Dipoles, Inverted-Vs, 1- λ Loops, and Doublets

L. B. Cebik, W4RNL

The preceding two sets of notes have developed a data compendium on the performance of basic NVIS antennas, with special reference to the dipole, the inverted-V, and the 1- λ loop. Our focus on these antennas has centered on fixed stations with well-prepared installation sites. Therefore, we sought to identify for each of the three soil types in our survey the antenna height for peak zenith gain, along with other trends that are relevant to performance. One collection worked with isolated or unsupplemented antenna elements, while the other collection featured both parasitic and planar reflector systems for the fed elements.

In the present exploration, we shall change our perspective. Instead of letting the antenna reach its peak zenith gain at whatever height might emerge, we shall work with some practical antenna heights that are typical of amateur installations. Fortunately, some of these heights happen to correspond closely with the natural heights for maximum zenith gain. For most level NVIS antennas, a height of 0.175- λ is close to the center of the range of optimal heights for all soils. Very good soils need a slightly lower height, while very poor soils need a bit more height. However, we saw that gain changes fairly slowly in the region of maximum zenith gain, so our use of a single value to capture the best NVIS height for level antennas (such as linear dipoles and 1- λ loops) will not be far from perfect. Two of the heights amateurs often use for wire antenna supports are 50' and 25'. The former comes close to the proper height on 75 meters, while the latter is about right for 40 meters. Along the way, we shall look at some alternative heights for inverted-V antennas. As well, we shall look at 35' in two ways, first, as an alternative to the optimal height and second, as a compromise so that we may connect two antennas together with a common feedpoint.

We shall look at a number of antennas and combinations of antennas. Of course, the dipole, the inverted-V, and the 1- λ loop will undergo some close scrutiny within the confines of our height limitations. Then we shall begin pairing 75- and 40-meter antennas, initially stacking them both in-line and at 90° angles but keeping the feedpoints independent of each other. Next we shall look at the performance of crossed dipoles and inverted-Vs that use a common feedpoint. We can also create a 2-band array of nested 1- λ loops, one inside the other. Our next antenna will be both simpler and more complex than the others. It consists of a single center-fed 104' wire, but using it will require an antenna tuner at some point between the equipment and the antenna proper. Finally, we shall briefly look at a trap dipole and trap inverted-V for 75- and 40-meter NVIS use. All of the antennas will use AWG #14 copper wire.

These selections do not exhaust our options for practical NVIS antennas. Still, they provide a broad selection of possibilities for performance comparisons. As well, they provide some broad outlines of the 3-dimensional space requirements required for a NVIS antenna installation. Their true function is not to guide actual antenna construction, but rather to form a background for antenna planning. To the antenna performance specifications, the antenna planner must bring detailed information on the antenna site, available resources, and mission specifications. Engineering—even at an amateur level—an antenna installation is not as casual an affair as some beginners believe. Good electrical and mechanical design and construction become even more important if the NVIS station has emergency communications as part or the entirety of its mission. The data in this set of notes provides only one set of pieces in a relatively complex jigsaw puzzle.

The Practical NVIS Dipole for 75 and 40 Meters

The standard linear or level dipole is so common a wire antenna on the lower HF bands that it seems to scarcely need mentioning. In fact, the most common backyard lower HF dipole installations are NVIS antennas, since amateurs rarely can achieve heights approaching $\frac{1}{2}\lambda$ or more on 75 and 80 meters. Indeed, 40-meter dipoles rarely reach $\frac{1}{2}\lambda$ (about 70').

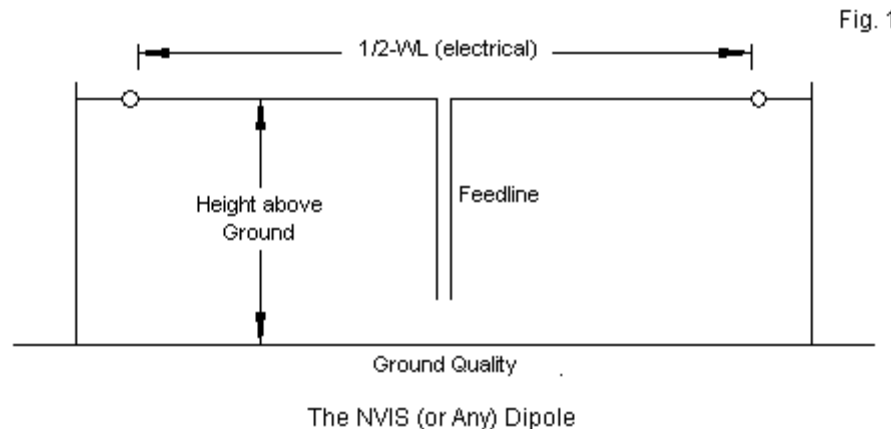
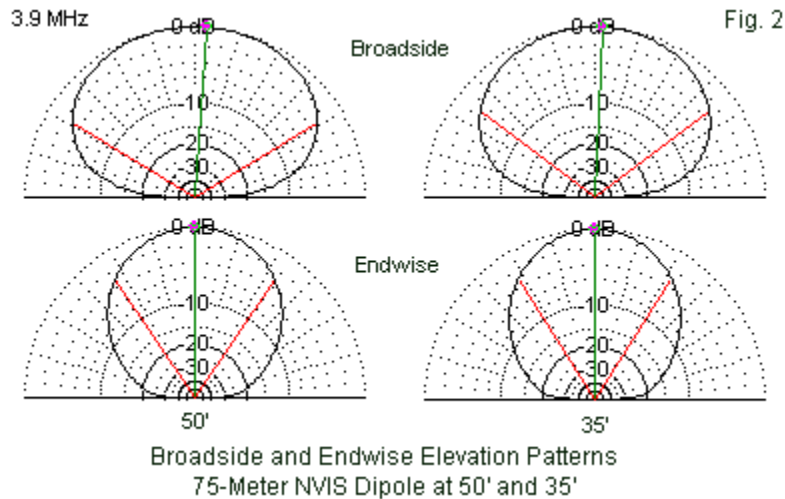

Fig. 1 shows the main components of a dipole installation, including two end supports, end insulators and ropes, a wire element fed at its center, and a feedline, normally coaxial cable. Most installation would also add a common-mode current attenuator at the feedpoint of the dipole and almost any other antenna. As a NVIS antenna within the constraints of these notes, the height above ground will be either 50' or 35' on 75 meters and either 35' or 25' on 40 meters. **Table 1** provides performance data for these options.

Dipoles	AWG #14 Copper Wire		Table 1						
Band M	Height ft	Length ft	Soil	Zen Gain	BS BW	EW BW	BW Ratio	Feed R	Feed X
75 3.9 MHz	50	121.20	Vy Good	7.29	112.2	67.8	1.65	71.01	7.48
			Average	6.40	117.8	67.8	1.74	73.76	0.14
			Vy Poor	5.13	127.2	68.4	1.86	75.02	-9.74
	35	121.20	Vy Good	7.30	101.6	64.4	1.58	48.73	6.71
			Average	6.07	106.8	65.2	1.64	57.73	0.86
			Vy Poor	4.59	115.8	66.8	1.73	66.82	-8.67
40 7.2 MHz	35	65.90	Vy Good	6.48	127.2	74.4	1.71	87.62	6.00
			Average	5.65	131.6	73.2	1.80	84.17	0.26
			Vy Poor	4.58	137.2	72.2	1.90	79.78	-5.64
	25	65.56	Vy Good	7.14	110.4	66.7	1.66	66.64	8.72
			Average	6.07	116.4	66.4	1.75	69.16	0.08
			Vy Poor	4.78	124.8	67.0	1.86	70.93	-9.27
Notes:	Zen Gain = maximum zenith gain in dBi								
	BS BW; EW BW = broadside and endwise beamwidths in degrees								
	Feed R; Feed X = feedpoint resistance and reactance in Ohms								

The table lists modeled dimensions for the dipole if composed of AWG #14 copper wire. On 75 meters, 121.2' will resonate at 3.9 MHz at either height over average soil. The dimensions must change very slightly for both better and worse ground qualities. As well, the dimensions might also change due to the proximity of objects within the installation site, since the model presumes flat, uncluttered terrain. Still, the numbers provide a starting point for field adjustments.

As the 75-meter entries show, the 50' height, if achievable, provides superior zenith gain performance, since the height is close to the generalized optimum height of 0.175λ . The advantage shows up more clearly as we decrease the soil quality. In addition, the pattern becomes more oval and less circular for either height as we decrease ground quality. **Fig. 2** provides broadside and endwise elevation patterns for both heights. As we raise the height of a NVIS dipole, the oval becomes more elongated in the broadside direction. This fact may have a bearing upon the orientation of the antenna for some installations and missions.



A wire dipole will not allow coverage of the entire 80-75-meter band, but it does suffice for the main part of the SSB portion at 75 meters. **Fig. 3** shows the SWR curves for both heights referenced to the resonant feedpoint impedance over average ground. As the curves indicate, the 50' curve is flatter than the 35' curve. In addition, the tabular impedance data suggests that the lower height is a better match for a 50- Ω feedline, while the 50' heights better matches a 70- Ω coaxial cable.

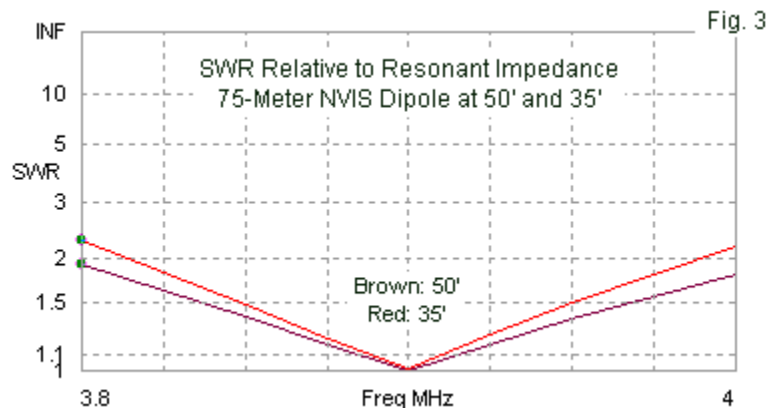

On 40 meters, the table offers a choice between heights of 35' and 25'. In this case, we obtain better zenith gain performance at the lower height, which is closer to 0.175λ above ground. On 75 meters, our choices were a near-optimal height and a height below optimum. On 40 meters, we can select between a near-optimal height and another above the optimal level. If we examine the patterns in **Fig. 4**, we can see one effect of raising the antenna too

height for best NVIS operation. At 35', the broadside pattern has already split into to maximum gain lobes offset from the zenith or straight-upward direction. The beamwidth ratio reflects the greater ovalization of the pattern. For strict NVIS operation, a more circular pattern is desirable, but some missions may favor the pattern stretch broadside to the wire.

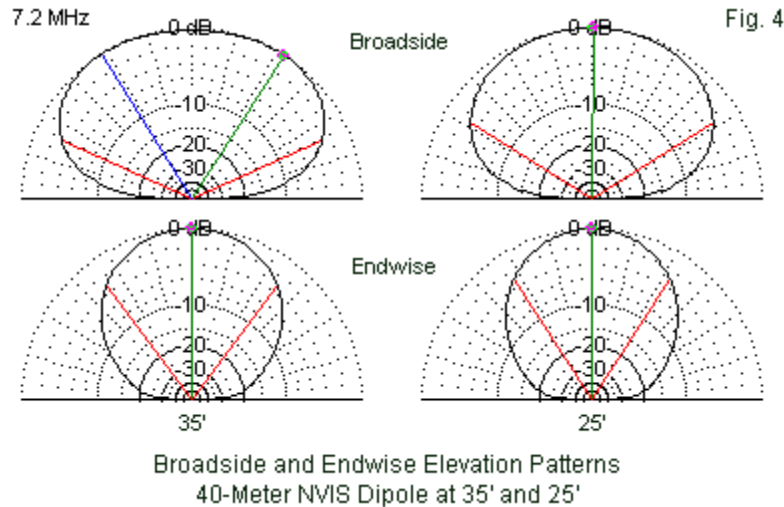

At either height, the wire dipole may cover the entire 40-meter band in terms of the SWR curves referenced to the resonant impedance over average soil. **Fig. 5** provides both curves. An actual installation might wish to lengthen the listed length values for the element to center the curves within the band. Note that on 40 meters, the two listed heights call for about a 5" difference in element length, with further adjustments needed as the soil quality changes. At 25', the feedpoint impedance favors a match with 70-Ω cable, while at 35', the impedance is a bit higher. In a practical installation at 35', the length of coaxial cable usually needed to reach the equipment would introduce sufficient loss to reduce the equipment end SWR levels.

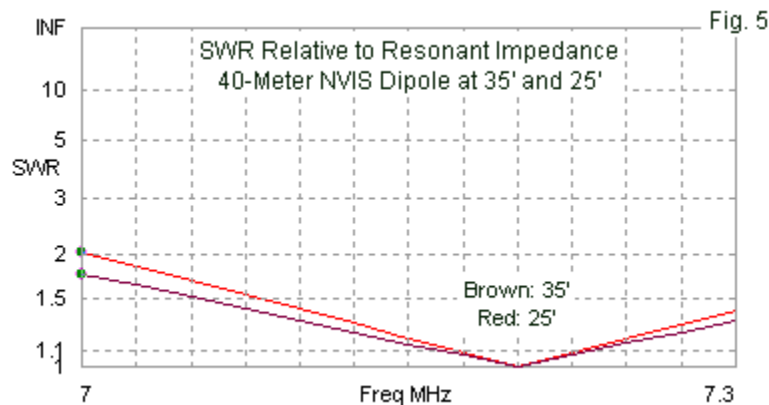

In principle, a NVIS dipole should use the height that yields best performance. However, as a practical matter, most installations may be forced to use other reasonable heights based on available supports and other site factors. The tabular data shows a modest degradation of performance at the alternative heights, but the overall level of performance is close enough to optimal that we can expect good performance from the alternative. The 75- and 40-meter NVIS dipoles provide a standard against which we can measure other basic NVIS antennas.

The Practical NVIS Inverted-V for 75 and 40 Meters

As we found in earlier notes within this series, the inverted-V center-fed dipole requires a greater center height for maximum performance than a level dipole. Wire-end coupling to ground tends to reduce the effective height of the inverted-V relative to its effective height when placed well above ground for long-distance communications. **Fig. 6** outlines the inverted-V that we shall use: AWG #14 copper wire with a 30° slope from the horizontal (or a 120° included angle). Shallower slope angles will produce performance intermediate between the sample V and the linear dipole. Greater slope angles generally produce weaker zenith performance.

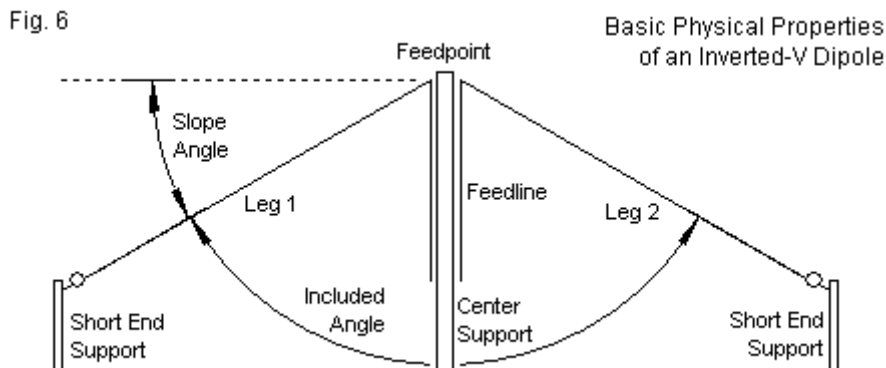

The 75-meter center height options are 60' and 45', while the 40-meter options are 35' and 25'. **Table 2** provides the modeled data for all of these options over the standard three types of ground quality.

Inverted-Vs		AWG #14 Copper Wire							Table 2	
Band M	Height ft	Length ft	Soil	Zen Gain	BS BW	EW BW	BW Ratio	Feed R	Feed X	
75 3.9 MHz	60	122.10	Vy Good	6.42	112.2	78.6	1.43	62.09	7.37	
	End ht	29.48	Average	5.50	118.0	77.4	1.52	66.05	-0.19	
	End len	52.87	Vy Poor	4.26	127.2	76.2	1.67	66.96	-10.73	
	45	121.30	Vy Good	5.93	101.8	81.4	1.25	46.76	6.53	
	End ht	14.68	Average	4.59	107.2	80.4	1.33	57.05	-0.35	
	End len	52.52	Vy Poor	3.14	116.4	79.8	1.46	65.95	-13.10	
40 7.2 MHz	35	66.22	Vy Good	6.17	117.8	78.8	1.49	67.93	7.55	
	End ht	18.45	Average	5.24	123.8	76.8	1.61	67.41	-0.40	
	End len	28.67	Vy Poor	4.11	131.2	75.6	1.74	65.48	-8.70	
	25	65.76	Vy Good	5.67	104.0	80.8	1.29	50.85	9.87	
	End ht	8.50	Average	4.27	109.6	79.0	1.39	58.66	-0.20	
	End len	28.47	Vy Poor	2.94	118.4	78.8	1.50	63.93	-11.89	
Notes:	End ht = height above ground in feet of each end of inverted-V									
	End len = distance in feet from V center to wire end parallel to ground									
	Zen Gain = maximum zenith gain in dBi									
	BS BW, EW BW = broadside and endwise beamwidths in degrees									
	Feed R, Feed X = feedpoint resistance and reactance in Ohms									

The table shows the total element length, but adds two other figures for each version of the inverted-V. The end height is the height of the wire tip (excluding end ropes and insulators) above ground. The end length is the horizontal distance parallel to the ground from the center of the antenna to the wire end. Double the end length to obtain the total horizontal distance needed for an inverted-V installation. One advantage of the V-configuration for some sites is

the reduced linear space needed for the antenna, while the need for a single tall center support and two shorter end supports is often a second attraction.

On 75 meters, the available zenith gain, even at the 60' center height, does not match the gain of a level dipole at optimal height. However, the performance is quite adequate for many situations, and the pattern does show greater circularity relative to a dipole pattern. The V radiates more effectively in the endwise direction than the level dipole, contributing to the reduction in the ovalization. **Fig. 7** shows the broadside and endwise elevation patterns of the V at both center heights. You may wish to compare the shapes of the endwise patterns, especially at low elevation angles, to corresponding 75-meter dipole endwise patterns.

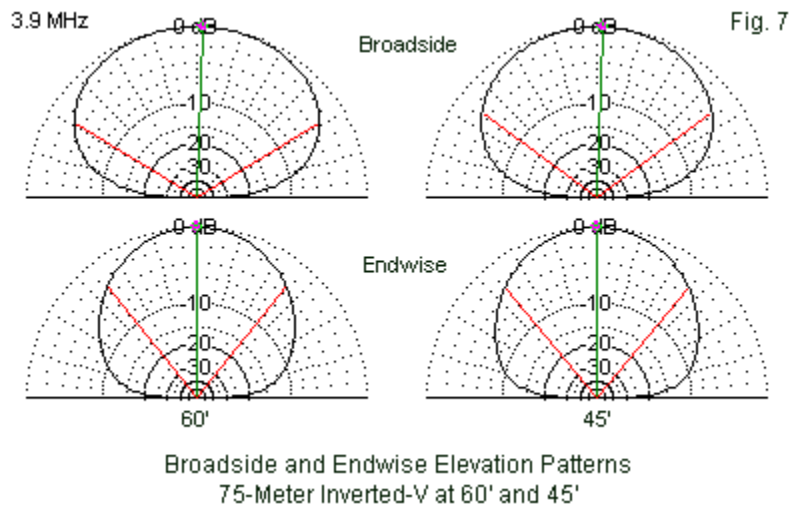

The inverted-V provides adequate SWR coverage of the SSB portion of the 75-meter band, as shown by the SWR curves in **Fig. 8**. The impedance data in the table show the 60' center height to have a stable resistive component that favors a match to 70-Ω cable. However, at 45' above ground, wire ends are sufficiently close to ground to create a wide swing (nearly 20 Ω) of the feedpoint resistance with changes in ground quality.

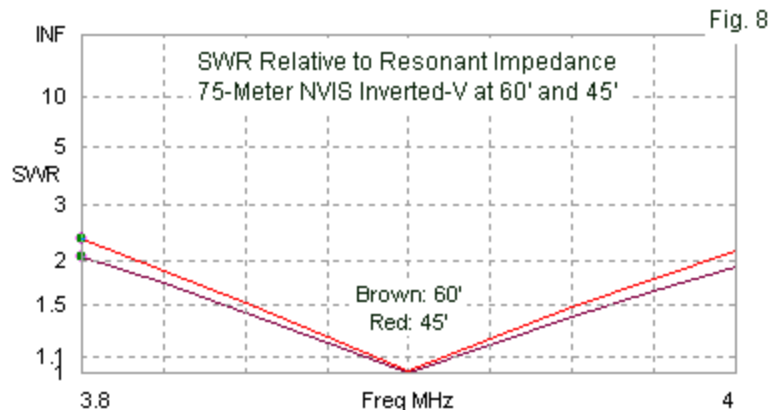

Some amateurs attempt to install 75-meter NVIS antennas using center heights below the shorter of our two options. The cost is a continued reduction in zenith gain, which tends to fall off very rapidly as we bring down the center height and tie off the ends very close to the ground.

On 40 meters, the two alternative center heights are 35' and 25'. The lower height proved better for the level dipole, but for the inverted-V, the higher center support provides superior zenith gain. As well, the 25' height for the V results in wire ends only about 8.5' above ground, which may fall below the safety level for a fixed installation. (A temporary field installation may need to use lower heights for wire ends—with suitable safety flagging for personnel—but with consequential further reductions in performance.) **Fig. 9** provides broadside and endwise elevation patterns for the 40-meter options. Unlike the dipole at 35', the V at that center height does not show the splitting of the broadside lobe, although the canted angle of the maximum gain indicator line suggests that that the height is approaching the limit prior to splitting. In general, broadside beamwidth angles greater than 130° usually accompany the splitting of the maximum gain angles.

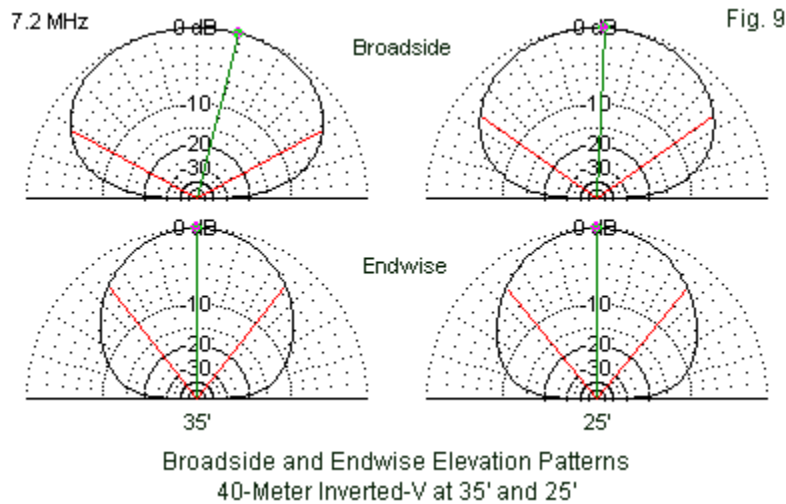

As the SWR curves in **Fig. 10** indicate, a wire V, even at the lower center height, is capable of covering all of 40 meters relative to the resonant impedance (over average ground). One may wish to lengthen the listed element length to better center the SWR curve within the band. The 35' center height tends to favor 70- Ω feedlines, while the lower 25' height yields feedpoint impedance values closer to 50 Ω .

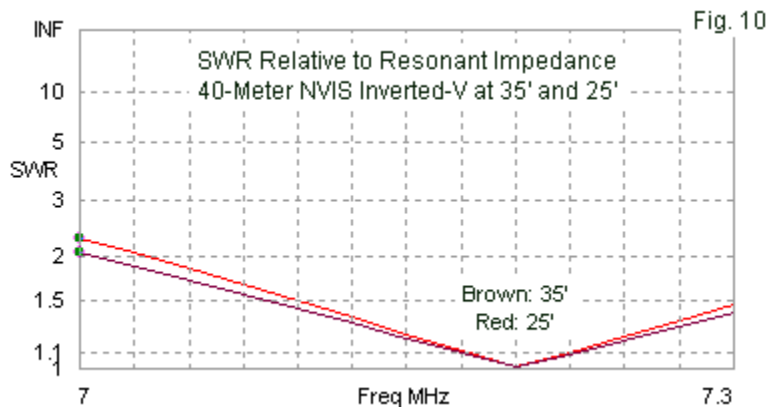

The inverted-V is often mechanically simpler as a NVIS antenna. However, even with an optimal center height, its performance, while adequate, does not match the performance of the

standard dipole. The critical factor in inverted-V installations is not to install the antenna at optimal dipole heights, but to select a higher center height to best optimize the effective height of the antenna.

The Practical NVIS 1-λ Loop for 75 and 40 Meters

As a level antenna, the 1-λ loop shows height properties similar to those of the level dipole. Therefore, we shall look at the 75-meter version at 50' and at 35'. The 40-meter height options will be 35' and 25'. **Fig. 11** outlines some of the critical aspects of loop installation, including the need for four tall corner supports. (Although the number may seem problematical for a single antenna, it will become less so when we consider multi-band installations.) We may select either a mid-side feedpoint (used in the models) or a corner feedpoint. The latter allows feedline support along the support post with no change in the tabulated data in **Table 3**. The only differences are the physical axes for the broadside and endwise radiation patterns that move from a side-to-side orientation to a corner-to-corner perspective.

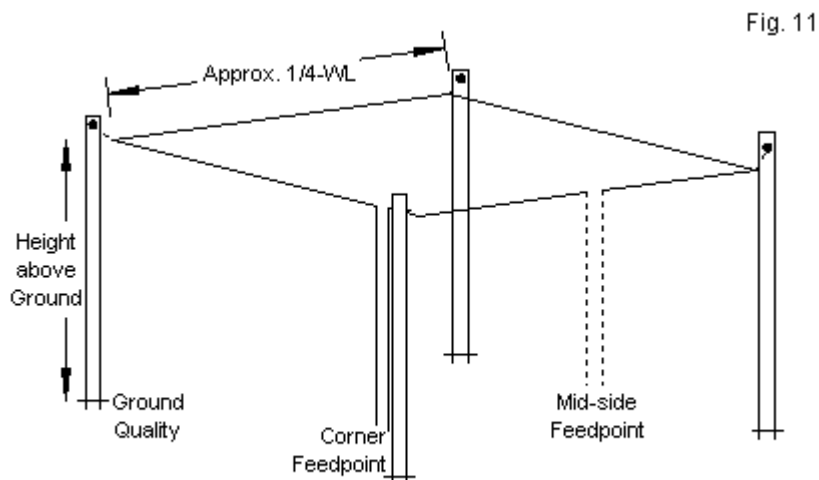

Key Properties of a Square 1-WL Closed NVIS Loop

1-WL Loops		AWG #14 Copper Wire							Table 3	
Band M	Height ft	Circum. ft	Soil	Zen Gain	BS BW	EW BW	BW Ratio	Feed R	Feed X	
75 3.9 MHz	50	259.04	Vy Good	7.87	89.8	71.6	1.25	136.40	15.72	
			Average	7.03	94.5	71.6	1.32	140.20	0.07	
			Vy Poor	5.86	102.4	72.2	1.42	139.50	-21.50	
	35	257.92	Vy Good	7.87	81.8	67.8	1.21	93.35	14.13	
			Average	6.70	85.3	68.6	1.24	109.00	0.15	
			Vy Poor	5.32	91.8	70.8	1.30	123.00	-24.01	
40 7.2 MHz	35	142.32	Vy Good	7.16	104.7	78.8	1.33	166.50	11.33	
			Average	6.39	110.1	77.4	1.42	158.00	-0.25	
			Vy Poor	5.41	117.2	76.6	1.53	146.60	-12.05	
	25	141.20	Vy Good	7.73	88.2	70.4	1.25	127.90	18.98	
			Average	6.74	92.6	70.0	1.32	130.60	0.43	
			Vy Poor	5.57	99.1	70.8	1.40	130.40	-20.54	
Notes:	Circum. ft = loop circumference in feet; divide by 4 for side length									
	Zen Gain = maximum zenith gain in dBi									
	BS BW; EW BW = broadside and endwise beamwidths in degrees									
	Feed R; Feed X = feedpoint resistance and reactance in Ohms									

Although 50' is close to optimal over average ground on 75 meters, the best height for very good ground is slightly lower—in the 40' to 45' range. Hence, the zenith gain values for both heights over very good ground are the same. The advantage of a 50' height appears as we reduce the ground quality, although the decline is slow. In all cases, the zenith gain of the loop is greater than the gain from a dipole at the same height and soil quality. In addition, the patterns for a loop are more circular than those for either a dipole or a V, as indicated by the lower values in the beamwidth-ratio column. The circularity of the loop patterns also appears in the broadside and endwise elevation patterns for both heights in **Fig. 12**. (It is possible to further circularize the NVIS pattern by shortening the fed wire and its opposite wire, and by lengthening the “side” wires—and to obtain a very small gain increase as well. However, this refinement is rarely practical in an amateur installation.)

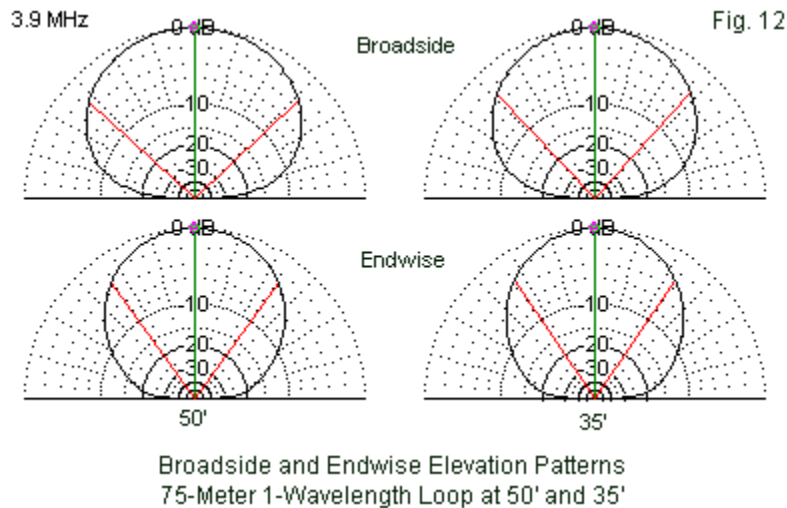

The impedance data shows wider swings of reactance as we change soil quality than we find with dipoles, but the effect of the swings on the SWR relative to a resonant impedance value is proportional to the resistive component value. The 75-meter SWR curves in **Fig. 13** are very similar to those for the dipole, despite the higher loop impedance. For a match to a 50-Ω coaxial cable, a $\frac{1}{4}\lambda$ series section of 70-75-Ω cable is usually satisfactory for impedance values up to about 130 Ω. For higher feedpoint impedance values, 93-Ω cable may prove more effective for the matching section.

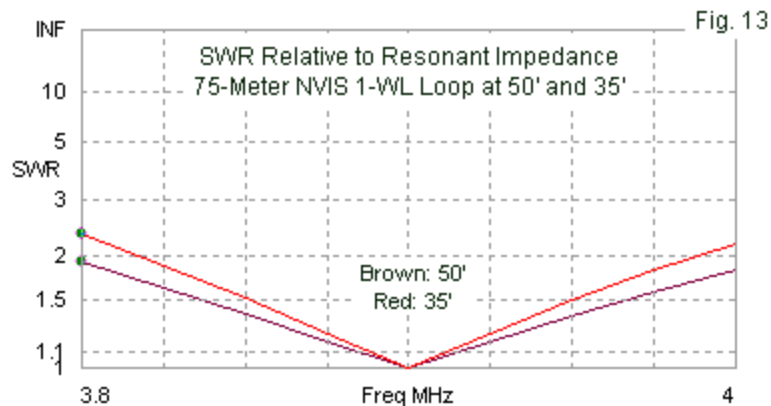

On 40 meters, the greater loop height shows its gain disadvantage over every soil type. Like the dipole, the loop at 25' is closer to an optimal height for NVIS operation and shares many of the properties of the 75-meter loop at 50' above ground. The broadside and endwise elevation patterns for 40 meters appear in **Fig. 14** to confirm the near circularity of the loop patterns when the antenna is at its best height. As we raise the loop above its best height, the pattern becomes more oval.

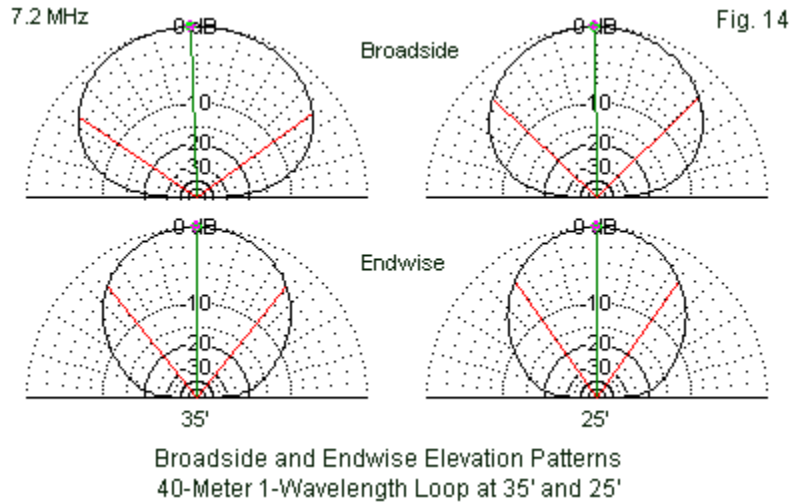

The 35' loop, being above optimal height, shows higher feedpoint impedances that suggest the use of a 93- Ω matching section. At 25', the impedance values are on the borderline that allows testing of each matching section impedance value for the widest 50- Ω SWR curve. The curves in **Fig. 15** are relative to the resonant feedpoint impedance over average ground for each antenna height. They confirm the ability of the loop easily to cover the entire 40-meter band.

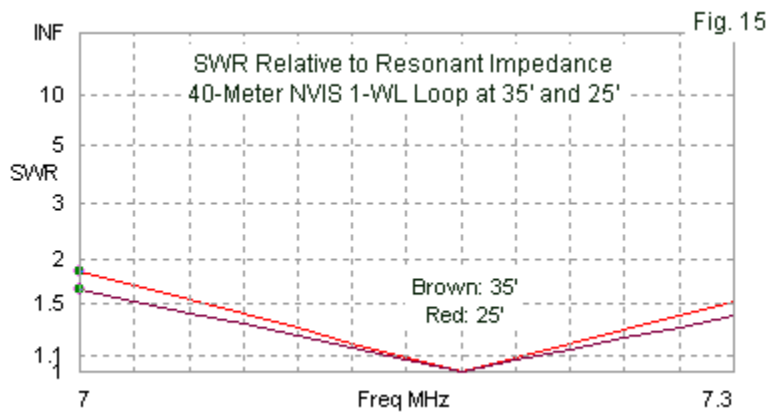

Despite the requirement for 4 tall corner supports, the 1- λ loop is a highly usable antenna. The dimensional values show the circumference of the wires, with each side having $\frac{1}{4}$ the value shown. The loop fits a square location that may not fully support a dipole's $\frac{1}{2}$ - λ total length. Moreover, the zenith gain level is somewhat higher for any height above any ground. A corner feedpoint permits full cable support, reducing strain on the element-to-cable junction. For some missions, the greater circularity of the patterns may also be an advantage.

Practical Multi-Band Antennas: Multiple Independent Dipoles

So far, we have looked in detail at monoband antenna installations. There are a number of highly practical ways to create antenna systems for both 75 and 40 meters besides widely separating independent monoband antennas. Our first candidate is simply to place two independent dipoles, each at its own best height, close to each other. **Fig. 16** outlines two options for us to consider. In each case, we shall place the 75-meter dipole at 50' above ground, with the 40-meter dipoles at 25'.

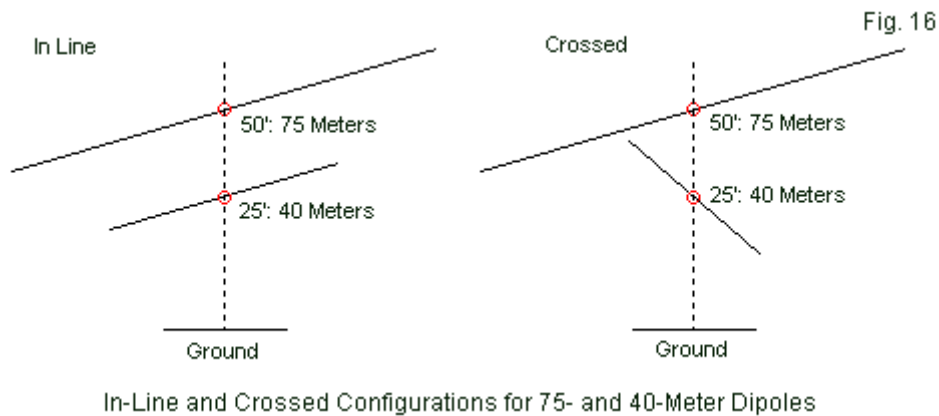

The in-line version of the dual independent antennas requires the fewest support structures. We only need to add two ropes to the 75-meter dipole support posts to hold up the 40-meter dipole element. In contrast, the crossed version demands 4 support posts, a pair for each band.

Paired Independent Dipoles			AWG #14 Copper Wire						Table 4
Band M	Height ft	Length ft	Soil	Zen Gain	BS BW	EW BW	BW Ratio	Feed R	Feed X
In Line									
75	50	121.20	Average	6.38	118.0	67.8	1.74	74.35	-0.61
40	25	65.16	Average	5.70	117.0	65.8	1.78	65.85	0.65
Crossed									
75	50	121.20	Average	6.40	117.8	67.8	1.74	73.76	0.14
40	25	65.56	Average	6.07	116.4	66.4	1.75	69.16	0.08
Notes:	Zen Gain = maximum zenith gain in dBi								
	BS BW, EW BW = broadside and endwise beamwidths in degrees								
	Feed R, Feed X = feedpoint resistance and reactance in Ohms								
	See Table 1 for approximate values over very good and very poor soil for crossed dipoles.								

Table 4 provides the performance data on models of the two systems. In both cases, the 75-meter dipole performance is unaffected by the orientation of the 40-meter antenna. If we cross the two antennas, each performs almost identically to independent antennas over the same average ground at the same height. You may confirm the values by comparing the present table with the appropriate entries in **Table 1**. However, the lower band dipole does have some significant effects upon the upper band element when both are aligned with each other. The required length for resonance changes, and the zenith gain decreases. Whether the gain difference between the two systems is enough to offset the differential in mechanical requirements is a user judgment, taking into account site, resource, and mission factors. In either case, the system requires two feedlines running to either a switch at the equipment room or to a remote switch closer to the antennas.

Practical Multi-Band Antennas: Crossed Dipoles and Vs with a Common Feedpoint

We may simplify the feeding system by using a dipole for each band, but at 90° to each other to minimize interactions. By using a common feedpoint, each dipole will resonate on its own band with minimal current on the element for the other band. **Fig. 17** shows the general outline of a pair of dipoles, although the system will also work with inverted-V elements. Like crossed independent dipoles, the common-feedpoint system requires at least 4 full-length support posts, one at the end of each element wire. As well, when we cross dipoles, the wider broadside beamwidth also changes by 90° as we switch bands. This aspect of the system may or may not be meaningful to a given installation or mission. In many cases, the site dimensions may override the desire to direct the broadside beam.

Fig. 17



Crossed 75- and 40-Meter Dipoles: Common Feedpoint

Table 5 provides modeled data for the crossed dipoles at two heights over average soil. (Past tables will allow close estimates of performance over other soil types.) For the moment, we need only examine the upper portion of the table for dipoles at 35' and at 25'. We find a disparity of gain at both heights between the values for 75 meters and for 40 meters. In addition, we find that the interactions between dipoles are minimal in terms of performance, but they do require adjustments to dipole lengths relative to the required lengths of independent dipoles at each height.

Crossed Dipoles with a Common Feedpoint					AWG #14 Copper Wire				Table 5	
Band M	Height ft	Length ft	Soil	Zen Gain	BS BW	EW BW	BW Ratio	Feed R	Feed X	
75	35	121.40	Average	6.08	106.6	65.2	1.63	58.21	0.21	
40	35	65.84	Average	5.66	131.4	74.4	1.77	82.60	-0.40	
75	25	121.60	Average	4.94	101.6	65.4	1.55	49.95	-0.56	
40	25	65.52	Average	6.09	115.8	66.8	1.73	68.42	-0.45	
Crossed Inverted-Vs with a Comon Feedpoint					AWG #14 Copper Wire					
Band M	Height ft	Length ft	Soil	Zen Gain	BS BW	EW BW	BW Ratio	Feed R	Feed X	
75	50	121.90	Average	5.06	110.2	87.6	1.26	60.38	0.11	
Wire End Height: 19.53'			Wire End Distance from Center: 52.78'							
40	50	66.94	Average	3.80	140.7	92.9	1.51	73.05	-0.05	
Wire End Height: 33.17'			Wire End Distance from Center: 28.99'							
75	35	120.10	Average	2.72	102.2	90.0	1.14	55.99	-0.17	
Wire End Height: 4.98'			Wire End Distance from Center: 52.00'							
40	35	66.20	Average	5.24	123.3	77.0	1.60	66.50	-0.45	
Wire End Height: 18.35'			Wire End Distance from Center: 28.67'							
Notes:	Zen Gain = maximum zenith gain in dBi									
	BS BW, EW BW = broadside and endwise beamwidths in degrees									
	Feed R, Feed X = feedpoint resistance and reactance in Ohms									
	See Tables 1 and 2 for approximate values over very good and very poor soil for crossed dipoles.									

The lower height is close to ideal for 40 meters, but very low for 75 meters. 35' is somewhat low for 75-meters, but already high for 40 meter NVIS dipoles. Although 50' would provide better 75-meter performance, 40-meter zenith gain would drop, because the broadside pattern would be split into two lobes with a very noticeable zenith null between them. **Fig. 18** provides broadside patterns for both bands at both array heights. At the upper height (35'), the 40-meter pattern already shows a split maximum-gain line pair with a tiny (operationally insignificant) gain decrease at the zenith angle. Further increases in height will rapidly increase the zenith null on 40 meters. The final selection of installation height for crossed dipoles will necessarily involve a compromise between the requirements of the two bands.

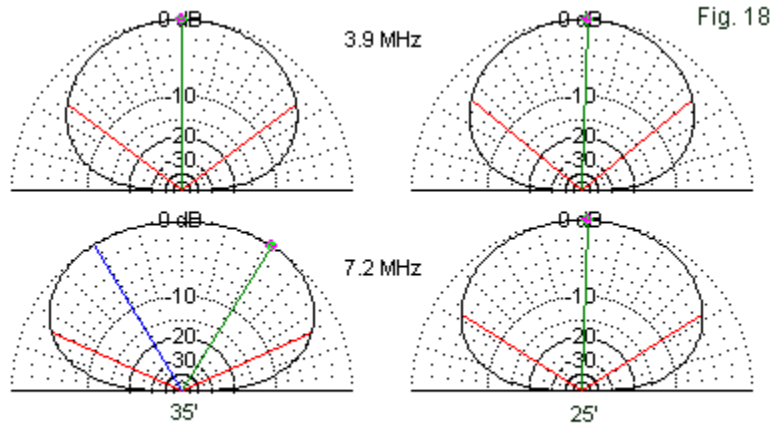

Broadside Elevation Patterns at 35' and 25'
Crossed 75- and 40-Meter Dipoles: Common Feedpoint

A mechanically attractive alternative to crossing level dipoles is to cross inverted-V elements. As suggested by the outline in **Fig. 19**, the system requires only a single tall center support, with shorter posts for the wire ends. For our sample, we shall use a 50' center support and a 35' center support to compare performance values on both bands.

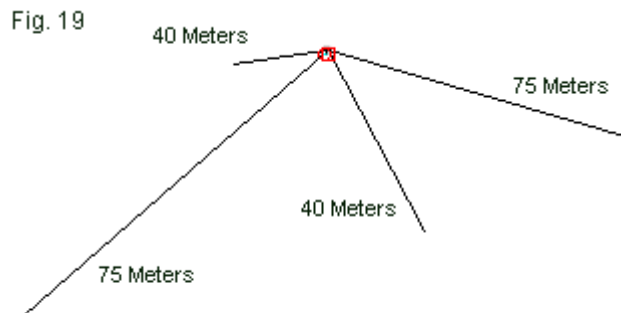

Crossed 75- and 40-Meter Inverted-V Dipoles
with a Common Feedpoint

Crossed inverted-Vs have performance disadvantages relative to crossed dipoles. Despite using elevated center heights for both the higher and the lower arrays, the overall gain values are less than the values for the dipoles. In addition, we find a wider disparity between the zenith gain values for each band. Even if we find a "perfect" center height that yields nearly equal zenith gain values on each band, those values will fall well below the gain values that we can obtain from crossed dipoles.

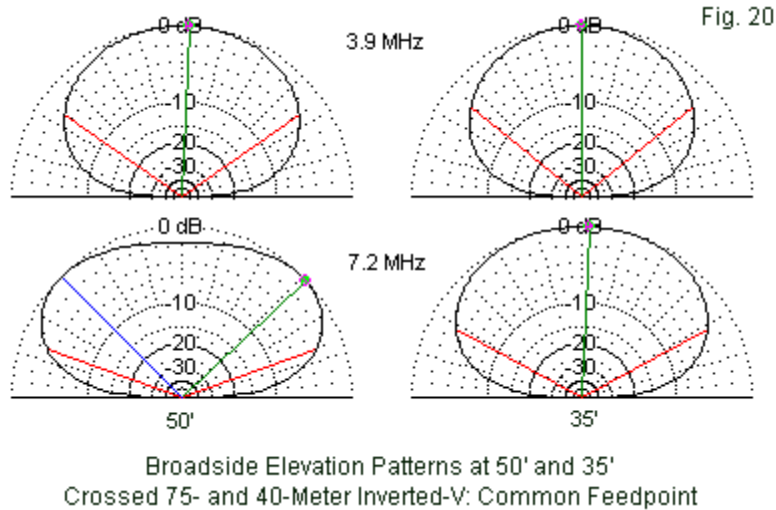

Finding the ideal height for crossed inverted-Vs will involve more than just gain equalization. As shown in **Fig. 20**, the 40-meter broadside elevation pattern shows serious lobe splitting and a very wide broadside beamwidth. We may also examine the dimensions for the Vs in **Table 5** and uncover an additional installation temptation. At either height, the 30° sloping Vs place the 40-meter wire ends much higher above ground than required by the 75-meter V. The temptation would be to use a greater slope angle (that is, a smaller included angle) for the 40-meter V. The smaller angle also promises to lower the 40-meter impedance to a value that more closely matches the 75-meter value. However, as we decrease the included angle of an inverted-V (or any half-wavelength V-element), the gain decreases along the V-axis. The already low zenith gain of the 30° V element would drop to even less desirable levels.

The sequence of crossed-element arrays has shown a continuously growing number of performance compromises. With crossed independent dipoles, each at a nearly optimal height, we obtained full performance from each, although with wider broadside beamwidths 90° apart. When we simplified the feed system by using a common feedpoint for both dipoles, we encountered reductions in the maximum available zenith gain due to the need to find a common height for both antennas. Converting the linear dipoles to an inverted-V configuration further reduced available zenith gain. From the starting point to the final inverted-V array, we lost as much as 3 dB, depending upon the final selection of antenna height and the slope angle of the inverted-V elements. Such losses may be mandated by temporary field installations, but a fixed station antenna system should carefully weigh the performance penalties of simplified mechanical construction if the station mission includes more than casual operation.

Practical Multi-Band Antennas: Nested 1-λ Loops

Multi-band dipoles and inverted-Vs require four to five support posts. When we compared monoband dipoles to 1-λ loops, we noted that the somewhat higher zenith gain of loops often fell prey to the desire for the simpler mechanical requirements of the dipole: 2 posts instead of 4. However, the mechanical advantage of dipoles and inverted-Vs becomes moot when we consider multi-band loop installations. We may nest 1-λ loops for 75 and 40 meters within a single 4-post support system. Moreover, we may set each loop at a favorable height. For our sample, outlined in **Fig. 21**, we can set the 40-meter loop at 25' above average ground, with the 75-meter loop 10' higher to obtain matched gain levels. One advantage of the nested loops is that we may also orient the broadside patterns in the same direction.

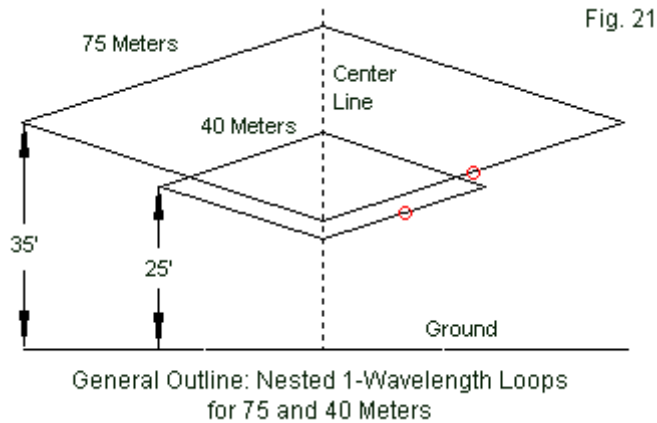
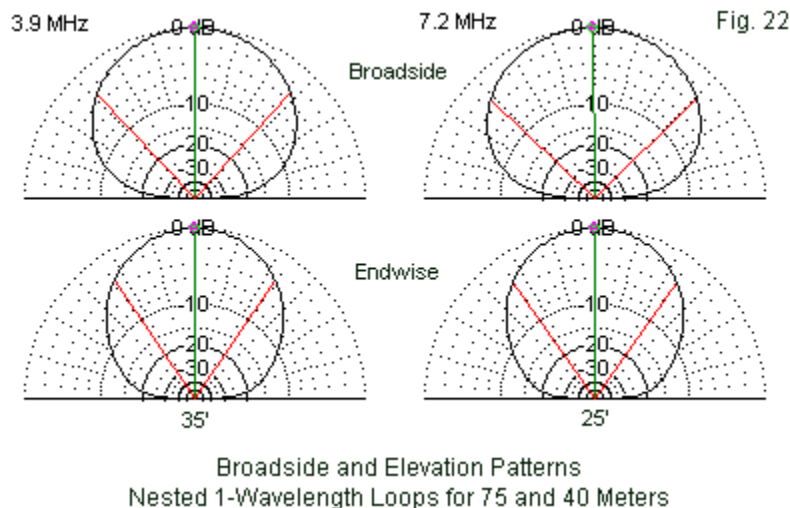

Table 6 provides numerical data for the pair of loops. Not only do both loops share a nearly common zenith gain value, but as well, the beamwidth ratio is almost the same on both bands. Despite nesting, the performance data for the individual loops is nearly the same as for independent loops, such as those shown in **Table 3**. However, the proximity of the loops yields some revision of the loop dimensions relative to monoband versions. Since the 75-meter loop is nearly 2λ in circumference on 40 meters, it shows a low but not wholly negligible level of activity when we drive the 40-meter loop.

Nested 75-40-Meter 1-WL Loops				AWG #14 Copper Wire			Feedpoint		Match		Table 6	
Band M	Height ft	Circum. ft	Soil	Zen Gain	BS BW	EW BW	BW Ratio	Feed R	Feed X	Feed R	Feed X	
75	35	257.92	Average	6.71	85.2	68.6	1.24	105.50	1.09	46.52	-0.55	
40	25	140.00	Average	6.66	92.4	70.0	1.32	135.30	-0.69	63.42	0.19	
Notes: Circum. ft = loop circumference in feet; divide by 4 for side length												
BS BW; EW BW = broadside and endwise beamwidths in degrees												
Feed R; Feed X = feedpoint resistance and reactance in Ohms												
Match = 1/4-WL series matching section: 75-meter section = 70 Ohms; 40-meter section = 93 Ohms												

Fig. 22 shows the performance similarities for the two nested loops graphically by providing the broadside and endwise elevation patterns for both bands. Similar performance is possible from a practical installation by carefully calculating, measuring, cutting, and installing support ropes from each corner posts. Although the models use mid-side feedpoints, corner feedpoints are equally applicable to the array.



The relationship between the two operating frequencies militates against trying to feed both loops from a common feedpoint. The two independent feedpoints have significantly different impedance values, and both require $\frac{1}{4}\lambda$ series matching sections. The columns showing the alternative feedpoint impedance values employ a 70- Ω matching section on 75 meters and a 93- Ω section on 40 meters. **Fig. 23** shows the 50- Ω SWR curves on both bands with the prescribed matching sections. Of course, in an actual installation, the builder would measure the resonant feedpoint impedance on each band before deciding upon the proper matching-section characteristic impedance.

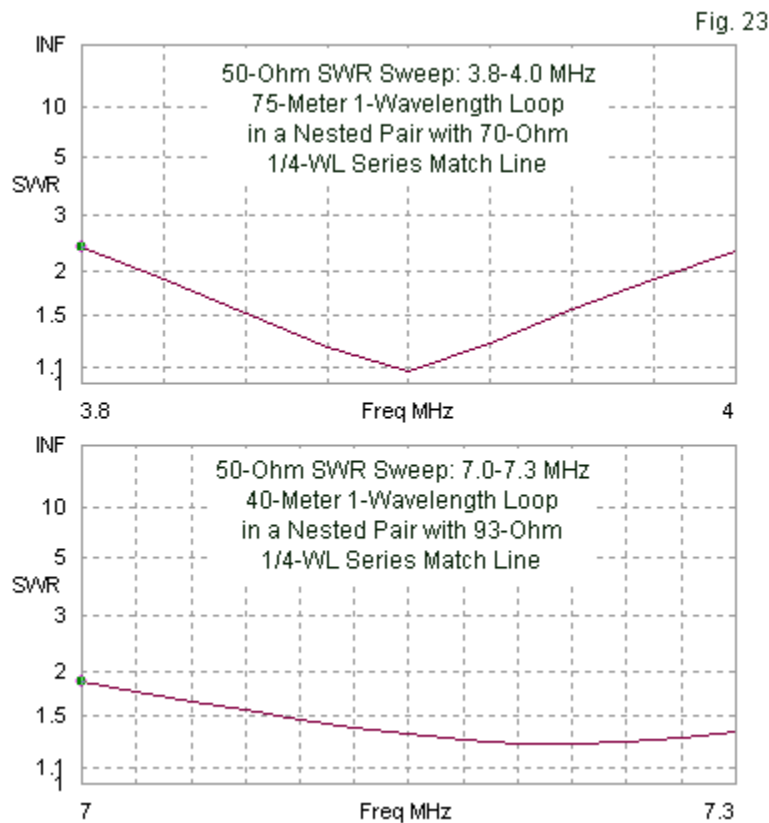

For multi-band service, 1λ loops become more attractive since they do not require more support structures than we would need for crossed dipoles or inverted-Vs. Their additional gain and the ease of matching them to a 50- Ω main feedline suggest that they deserve serious consideration, especially for installation sites that may strain to handle a full half-wavelength of linear space. Nested loops require a little over $\frac{1}{4}\lambda$ per side on the lowest band in the loop nest.

Practical Multi-Band Antennas: A Center-Fed Doublet

Those who can manage only two supports may wish to consider a largely overlooked option for a NVIS antenna: a center-fed doublet. **Fig. 24** shows the outline of one possibility. Although it looks like a common dipole, it is not. Rather, it will function as a center-fed element that ranges from about 0.4λ on 75 meters to about 0.75λ on 40-meters. In addition, we may operate the doublet on 60 meters, where it is just over 0.55λ long. For our sample, we shall use a height of 35', which is higher than ideal for a $\frac{1}{2}\lambda$ 40-meter dipole, but nearly ideal for the longer length of the doublet.

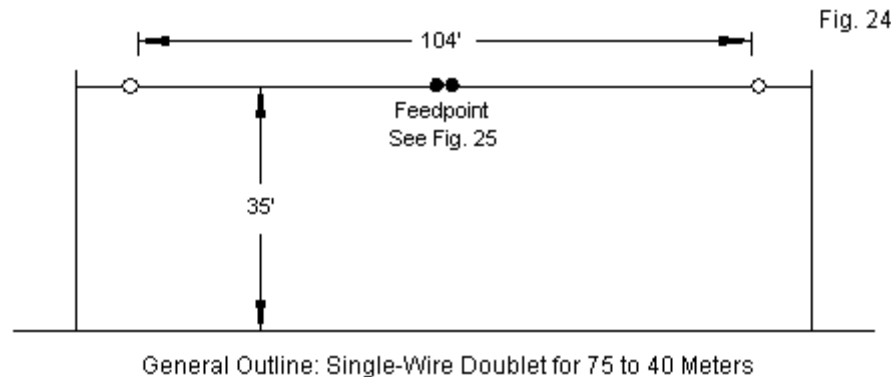

The length of the doublet resembles the length of a G5RV antenna/feed system. The resemblance is no accident, but has little to do with the reasoning behind the original system. It is possible to use a doublet that is a full half-wavelength long at the lowest operating frequency. However, as we nearly double that frequency (from 75 meters to 40 meters), the feedpoint impedance increases to values of resistance and reactance that are both over 2000 Ω. To restrict the impedance excursions of the antenna, we cut the doublet short for 75 meters, but still within a reasonable impedance range for most antenna tuners (ATUs). As a consequence, we obtain impedance values on 40 meters that are also more amenable to normal ATU tuning ranges. The feedpoint impedance values in **Table 7** for each band over all three soil qualities give a good feel for the values that require matching.

104' Center-Fed Doublet			AWG #14 Copper Wire					Feedpoint		w/Line	Table 7
Band M	Height ft	Length ft	Soil	Zen Gain	BS BW	EW BW	BW Ratio	Feed R	Feed X	Feed R	Feed X
75	35	104	Vy Good	7.16	101.5	66.2	1.53	31.60	-250.30	29.01	199.80
			Average	5.90	106.6	67.0	1.59	37.77	-253.90	34.20	195.80
			Vy Poor	4.40	115.8	68.8	1.68	44.04	-260.20	39.00	189.50
60			Vy Good	7.40	111.2	64.4	1.73	119.70	338.20	477.50	-946.60
			Average	6.43	117.2	64.2	1.83	123.10	324.00	537.10	-959.80
			Vy Poor	5.15	126.0	64.4	1.96	124.40	307.60	610.00	-981.50
40			Vy Good	7.14	127.2	61.0	2.09	682.60	1371.00	55.76	-53.43
			Average	6.34	131.6	60.2	2.19	638.90	1347.00	54.92	-57.52
			Vy Poor	5.30	137.2	59.8	2.29	590.60	1324.00	53.57	-62.07
Notes:	Zen Gain = maximum zenith gain in dBi										
	BS BW, EW BW = broadside and endwise beamwidths in degrees										
	Feed R, Feed X = feedpoint resistance and reactance in Ohms										
	w/Line = at source end of 33.5' or 450-Ohm, VF 0.9 parallel transmission line										

Using a doublet requires an ATU somewhere along the line between the antenna feedpoint and the station equipment. As shown in **Fig. 25**, we may select among three main positions for the ATU. On the left is perhaps the most common system for feeding a doublet: the use of parallel transmission line (600-Ω ladder line or 450-Ω window line) from the antenna to the equipment room with a balanced ATU located indoors. A manual tuner with a record of settings for each band usually provides adequate speed when switching bands except where automatic link establishment (ALE) procedures may be in use.

The system shown at the center of **Fig. 25** uses a length of parallel feedline to effect an initial impedance transformation to reduce the impedance range required of an ATU. **Table 7** adds two columns to record the modeled impedance values that result from the insertion of the line. Although the range for 75 and 40 meters is small, the values are not direct matches for a standard coaxial cable. In addition, if one adds 60 meters to the set of operating bands, then the value range is not vary different from the range of values at the feedpoint. The high-

impedance values simply occur of different bands. With the added line, system requires a weatherproof remote tuner located below the feedpoint. The weight of such a unit would likely require a third support for the antenna. Nevertheless, the remote tuner, if equipped with memories, would permit rapid band switching.

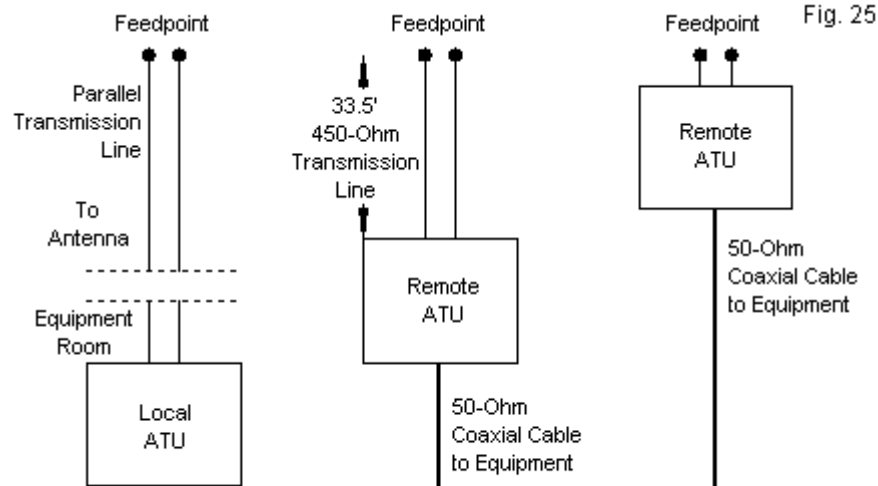

Alternative Methods of Feeding the 75-40-Meter Doublet

We may also install the remote tuner directly at the antenna feedpoint, again with weatherproofing and a suitable support for the weight. Remote ATUs currently available have different matching ranges, running from quite small to very wide. Therefore, selection of the ATU for either remote system is a major installation decision.

A doublet at about 35' above ground provides relatively even band-to-band performance as a consequence of the increasing length of the element as we raise the operating frequency. The zenith gain numbers for comparable soil qualities confirm the near uniformity of performance. The broadside and endwise elevation patterns in **Fig. 26** confirm the impression left by the tabular data.

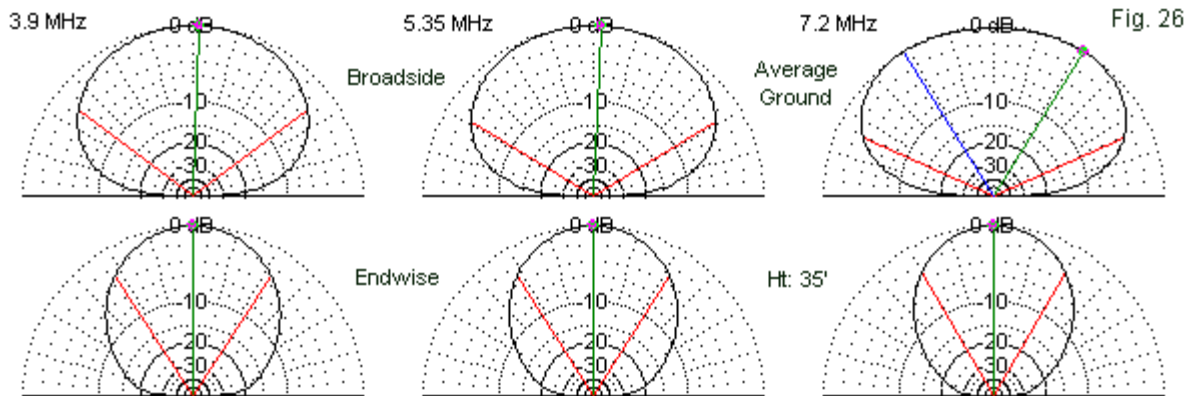

Broadside and Endwise Elevation Patterns: 75-40-Meter Doublet

As we increase the length of a center-fed wire element (or raise the operating frequency, which amounts to the same thing), the zenith gain rises and the beamwidth narrows. However,

with a fixed height above ground, increasing the operating frequency also increases the height in wavelengths above ground, which results in a wider beamwidth broadside to the antenna element with a lower zenith gain value. By judiciously selecting a physical height for the antenna, we may balance the conflicting trends—at least to a level that yields adequate performance over a wide range of frequencies. In general, the doublet at 35' above ground provides performance that is similar to the performance of 3 independent half-wavelength dipoles, each near its optimum height for maximum zenith gain. The one deficiency in performance, relative to the independent monoband dipoles, is that the endwise beamwidth continues to diminish with rising operating frequencies.

Although the preceding set of notes has adequate information for estimating the benefits of a full screen at ground level for the major type of antennas that we have been reviewing, we have no data directly applicable to the doublet. Therefore, I created a near-ground screen below the doublet, as shown in **Fig. 27**. The screen is $1-\lambda$ per side at 75 meters, making it larger than necessary for higher frequencies.

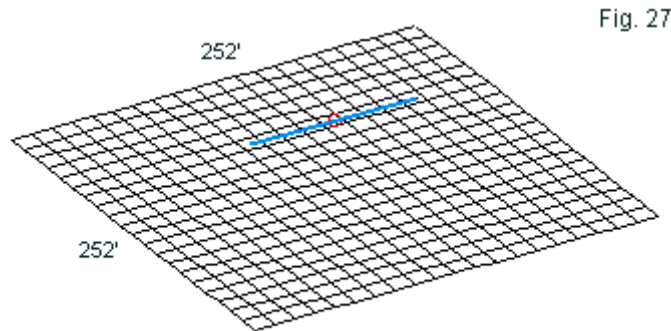

Fig. 27

104' Center-Fed Doublet with Near-Grouhd Screen

Table 8 provides numerical data that parallel the values shown in **Table 7**, without the screen in place. (The new table omits the extra impedance columns.) Pattern shapes do not significantly change, and the impedances values are not very far apart in the two tables, especially considering the application of an ATU to the feed system. As expected, the key benefit is to the zenith gain over lesser quality soils. Note that the gain values for 40 meters do not keep pace with those for the lower bands. The screen is simply oversized for that band.

104' Center-Fed Doublet with 1-WLx1-WL Screen					AWG #14 Copper Wire			Feedpoint	Table 8
Band M	Height ft	Length ft	Soil	Zen Gain	BS BW	EW BW	BW Ratio	Feed R	Feed X
75	35	104	Vy Good	7.73	99.0	65.6	1.51	29.36	-248.80
			Average	7.66	97.2	65.0	1.50	31.75	-247.90
			Vy Poor	7.83	93.2	63.6	1.47	33.31	-246.90
60			Vy Good	7.81	108.2	63.8	1.70	118.40	343.40
			Average	7.67	108.0	63.5	1.70	123.90	340.30
			Vy Poor	7.82	104.8	62.1	1.69	128.50	339.30
40			Vy Good	7.38	125.2	61.6	2.03	699.00	1380.00
			Average	6.92	126.8	63.6	1.99	690.40	1355.00
			Vy Poor	6.58	127.0	66.0	1.92	691.60	1332.00
Notes:	Screen is 1-WL by 1-WL at 3.9 MHz (252' by 252')								
	Zen Gain = maximum zenith gain in dBi								
	BS BW; EW BW = broadside and endwise beamwidths in degrees								
	Feed R; Feed X = feedpoint resistance and reactance in Ohms								

Additional engineering investigations might turn up a better compromise set of dimensions for the ground screen. Its use with the doublet will depend upon many factors, and so the information is not inherently a recommendation. Nevertheless, the basic doublet with any of the ATU systems shown is worthy of consideration, especially if land and support posts materials are limited.

Practical Multi-Band Antennas: Trap Dipoles and Inverted-Vs

Trap dipoles and inverted-Vs represent an alternative means of providing multi-band performance with only two end supports—and, of course, a center support for the V-configuration. **Fig. 28** provides a general outline of a trap inverted-V. The trap dipole has the same dimensions using a level wire element.

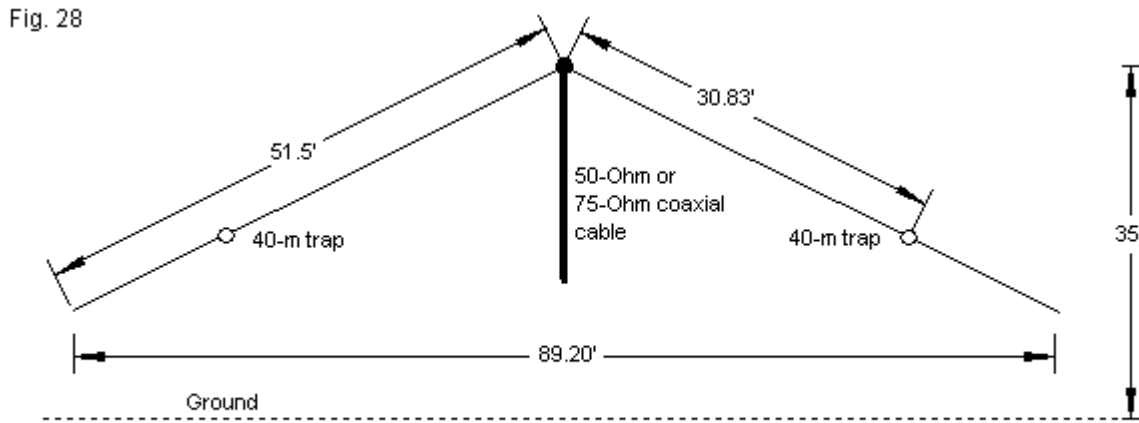

General Structural Outline: Trap NVIS Inverted-V for 75 and 40 Meters

Traps are parallel-tuned L-C circuits that we tune slightly lower in frequency than the lowest frequency used on the higher of the two bands. The traps used in the model require 60-pF capacitors and 8.7-μH inductors. Most conventionally wound coils have Q-values of about 200 or so, although a careful builder might achieve a higher value. As a compromise between the bands, both the inverted-V and the dipole versions of the 75-40-meter antenna have peak heights of 35', a level that is high for 40 meters and low for 75 meters, if we use the ideal heights for dipoles as our reference standard. In practice, the inverted-V peak height should be higher—perhaps 45' or so—but most amateurs who limit themselves to only two or three supports are unlikely to exceed the 35' height in the sample.

Trap Dipole and Inverted V				AWG #14 Copper Wire				Table 9	
Band M	Height ft	Length ft	Soil	Zen Gain	BS BW	EW BW	BW Ratio	Feed R	Feed X
Inverted V									
75	35	103.00	Average	2.73	102.5	86.2	1.19	49.21	-14.35
40	35		Average	4.84	123.3	76.8	1.61	75.65	-28.11
Dipole									
75	35	103.00	Average	5.65	106.6	66.6	1.60	51.28	-25.10
40	35		Average	5.46	131.6	71.0	1.85	93.68	-20.26
Notes:	Inverted-V wire end is 9.25' above ground and 44.6' from element center.								
	Zen Gain = maximum zenith gain in dBi								
	BS BW; EW BW = broadside and endwise beamwidths in degrees								
	Feed R; Feed X = feedpoint resistance and reactance in Ohms								

The modeled data appear in **Table 9**. The zenith gain for the inverted-V is low by virtue of the V-configuration and the low height. The dipole model over average ground has more equal gain values, but the 75-meter performance shows a deficit relative to individual dipoles over the same ground. The 40-meter gain value for the portion of the antenna inside the traps is comparable to the value of the 40-meter dipole at the same height for crossed dipoles using a common feedpoint.

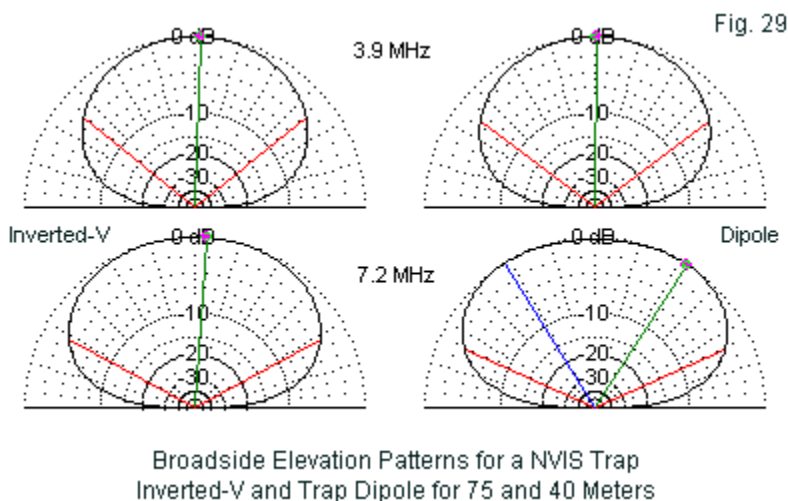

The use of traps imposes no revisions on the radiation patterns produced by the antenna. In **Fig. 29**, we find perfectly normal broadside elevation patterns for both versions of the antennas. The dipole version on 40 meters shows the split maximum-gain lines typical of dipoles above their optimum NVIS height.

One advantage of the trap multi-band NVIS antenna is the reduced linear space it requires. The level dipole version requires only 103' plus a small space required for end insulators and support ropes to the end posts. The inverted-V, with a 30° slope, needs less than 90' plus end-attachment space.

On 75-meters, the trap antenna exhibits impedance values that are compatible with 50-Ω coax. However, the 40-meter impedance values are higher. Prior to building a trap antenna for NVIS work, one might experiment with trap components, including the trap resonant frequency, to arrive at a better match for the usual coaxial cable feedline. The dipole version of the antenna has a total length similar to the length of the doublet. Both antennas have complexities, in one case the traps, in the other the need for an ATU.

Conclusion

Our survey of practical NVIS antennas has included many basic types and variations, but it is by no means exhaustive. Beginning with basic dipoles, inverted-Vs, and 1-λ loops for monoband service, we progressed to various multi-band arrangements. Our goal has been to lay out the general structures of practical NVIS antennas and to compare performance level both at various normal amateur antenna heights and also among the antennas included. The overall goal of this set of notes has been to provide data that may be useful in planning and implementing a fixed-station NVIS antenna system for the two most commonly used amateur bands.

Unlike field antennas, which must employ simplified construction methods for rapid deployment, the fixed-station NVIS antenna system deserves careful attention to detail. Some NVIS stations engage almost solely in casual operation in order to sample the propagation mode. Such stations can take shortcuts with construction and live with the modest outcome. Many stations have more significant missions that include emergency communications work. Unfortunately, not all of them have the resources to implement optimal antenna systems. Of the systems that we have surveyed, one of the best—in terms of pattern circularity and zenith gain—is a set of nested $1-\lambda$ loops supplemented by a full ground screen for soil qualities less than very good. In amateur and local community terms, such a system is a relatively expensive proposition. As well, the antenna site often dictates antennas with different shapes and heights. Nevertheless, a fixed NVIS station with more than a casual mission would do well to engineer the best antenna system possible for the site and the operating goals. In many instances, the fixed station gain and radiation pattern properties must compensate for deficiencies in the field stations with which communications are essential.

For the fixed NVIS station with an important mission, casual design is not good enough, simply because we can do better. The notes in this collection provide some background data that I hope will contribute toward better NVIS antennas.