Reinventing the (Big) Wheel

L. B. Cebik, W4RNL (SK)

The search for a horizontally polarized VHF omni-directional antenna is as old as amateur use of their VHF allocations. In 1961, R. H. Mellen, W1IJD, and C. T. Milner, W1FVY, presented an improvement of the halo that has had enduring interest and provoked considerable construction frustration from time to time. They called their antenna "The Big Wheel on Two" (*QST*, September, 1961, pp. 42-45).

These notes will not so much reinvent the big wheel as they will revise the way in which we formulate its operation. Once we have taken that step, we shall discover that we may modify or revise the design in ways that will better meet our needs and simplify adjustments. In the process, we shall examine the process of modeling the 2-meter omni-directional antenna. All models of the antenna in these notes will use 146 MHz as the test frequency, because once we have the right view of the array and the right design for it, we shall discover that it easily covers all of the 2-meter band.

Changing the Way We Look at the Big Wheel

Mellon and Milner viewed their antenna as essentially 3 full-wavelength loops fed in phase, that is, fed in parallel. The left side of **Fig. 1** sketches this view in a simplified way. We shall discuss the feedpoint assembly shortly.

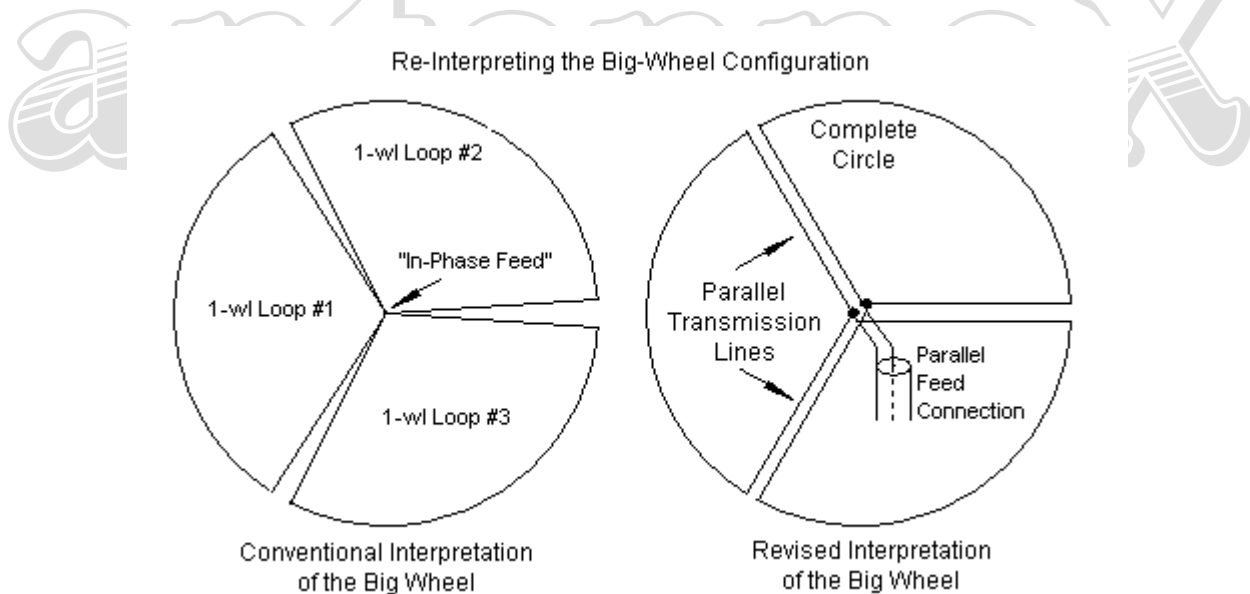

Fig. 1

Ideally, according to the original article, the outer rim of each loop should be $\frac{1}{2}\lambda$ long, with the legs to the feedpoint each being $\frac{1}{4}\lambda$ long. They formed their loops from 80" lengths of $\frac{3}{8}$ "-diameter tubing. Unfortunately, their view of the antenna is somewhat flawed.

First, a full-wavelength loop (with a circumference from about 0.75λ to 1.25λ) radiates broadside to the plane of the loop. However, the big wheel radiates off the edge of the assembly of loops. Moreover, even allowing for interactions among the loops, a full-wavelength closed geometry requires a circumference that is about 5% longer than a wavelength at

resonance. Unfortunately, we cannot simply dismiss these aberrations by suggesting that loop interaction causes them. The interactions run far deeper than mutual coupling between otherwise independent elements.

Let's revise our way of looking at the big wheel in accord with the suggestion on the right in **Fig. 1**. Let's presume that only the rim is effective in creating the radiation pattern. The rim is about 1.3λ to 1.4λ , but has 3 feedpoints, each one supplied by a length of transmission line. The lines join in parallel at the center. In fact, the diverging legs of the big wheel on the left form parallel transmission lines with a variable characteristic impedance—lower at the central hub and higher at the junction with the rim wire. Each outgoing and incoming loop leg carries identical current magnitudes that are opposite in phase. Hence, they have very little, if any, radiation. The antenna field results almost exclusively from the rim wire. Hence, we do not see much broadside radiation. Instead, the radiation from the rim forms the far-field pattern.

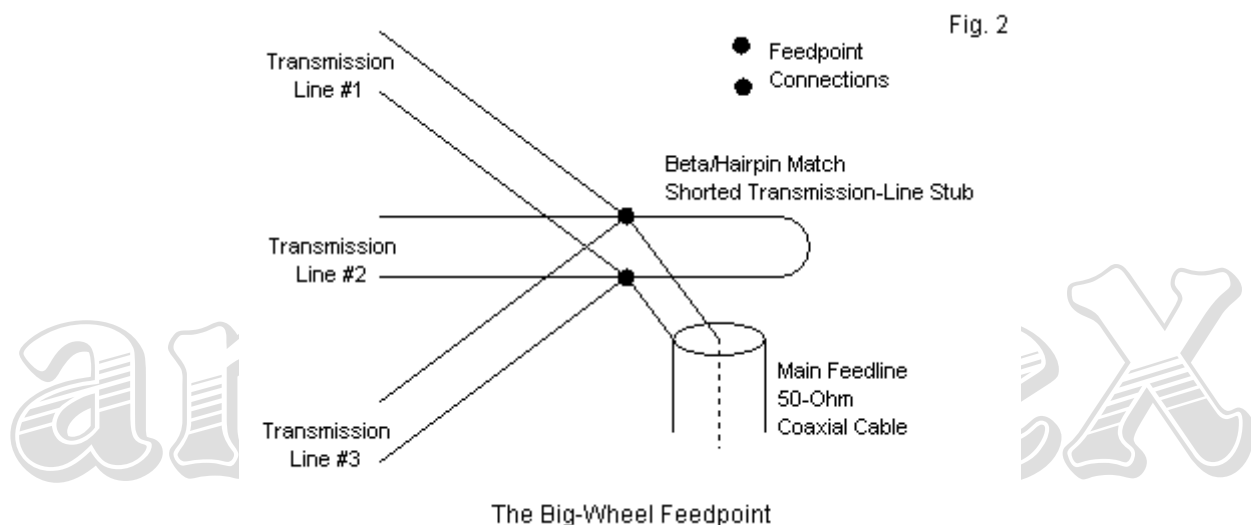
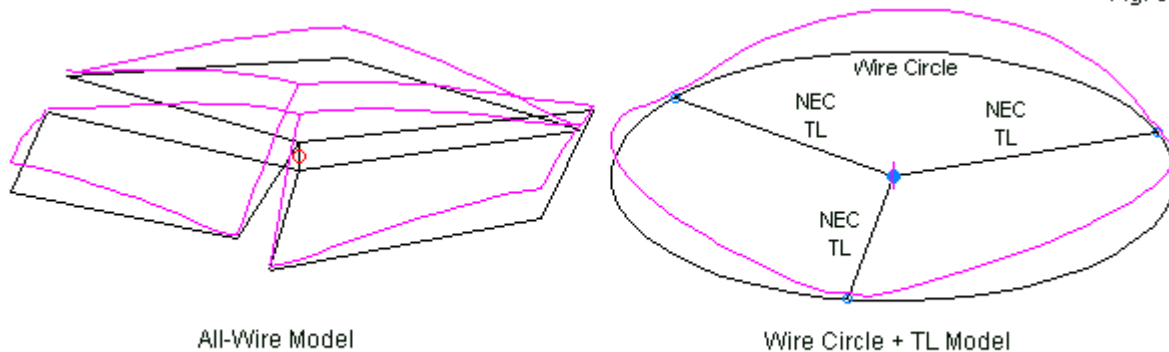

Fig. 2 shows the feed system used in the big wheel, a system that we shall retain for a while in these notes. The three legs or transmission lines join in parallel and connect to a main 50- Ω coaxial cable feedline. In 1961, the authors referred to stub tuning to obtain the 50- Ω impedance at their design frequency. Today, we would call this a beta or hairpin match. The combined impedance is low—in the mid-20- Ω resistance range. It is accompanied by a series capacitive reactance, also in the mid-j20- Ω range. By adding a shunt inductive reactance across the feedpoint, we create an L-network that transforms this load impedance to a 50- Ω resistive impedance on the supply side—at least at the design frequency. Before we conclude these notes, we shall free ourselves from the need for this particular matching system, although it is a good option. It would simply place a limit on our construction efforts to restrict ourselves to requiring it.

When modeling the big wheel, the alternative way of viewing the antenna allows considerable simplification of the model and lets us see more clearly how the antenna operates. I began with all-wire models of the antenna that initially only approximated the original design by using a rhombus for each loop. The left side of **Fig. 3** shows one of the initial models along with current magnitude distribution curves for each wire. To keep the wires separated and to prevent interpenetration of the surfaces, I used a vertical separation (ranging from 1" to 6") at the center.

The results included current peaks at the center of each rim wire pair and equal current magnitudes on the legs extending from the center source wire to the rim wires.

Fig. 3



Relative Current Magnitude Distribution on Different Models of the Big Wheel

The revised model on the right creates a simple circular element with a number of segments that is divisible by 3 (45 segments in most models). A center source wire provides the inner termination for three transmission lines that run from the hub to equidistantly spaced points along the perimeter. The simplified model provides the same gain and pattern shape as the all-wire model, but yields average gain test (AGT) values that are virtually ideal. The all-wire model tends to produce deviations in AGT scores that increase as we reduce the vertical length of the center wire and hence the separation of leg wires at the hub. The reported gain values and impedance values at the hub of the all-wire model are correctable, but the “loop + TL” model simplifies data gathering.

The models both show in what class of antennas the big wheel actually belongs. Its closest relative is the constant- (or uniform-) current loop. That device uses periodic capacitors along a wire to yield a series of current magnitude curves that are close to the same for each wire section between capacitors. The result is an omni-directional pattern with little or no variation of gain in any azimuth direction. Essentially, the multiple feedpoints along the rim of the big wheel achieve the same effect, but by significantly different means.

The Limitations of Modeling and Building the High-Impedance Big Wheel

The big wheel has proven to be somewhat difficult to replicate and even more difficult to model with buildable accuracy. **Fig. 4** can help us understand both difficulties. It portrays the situation at one of the three rim feedpoints, with the transmission line leading to the hub of the assembly.

Electrically, the rim impedance is very high. The transmission line forms an impedance transformer that is just over $\frac{1}{4}\lambda$ long, due to the velocity factor of the line. Ideally, we may specify a desired impedance for the hub end of the line. However, two factors limit our ability to obtain the specified impedance. One factor is the rate of change of impedance at the rim junction. Very small changes in the rim circumference and in the gap at the rim create large changes of the rim impedance. As a result, the hub-end impedance will also fluctuate. In other applications of such lines to high-impedance feedpoints, we experimentally determine the correct tapping point on the line. However, the second limitation of the system—the fixed length of the transmission line—allows us either no adjustment or exceptionally limited adjustment in

the line length. In addition, the rim does not present a purely resistive impedance at the gap. As a result, we find an uneliminable reactance that also appears at the hub end of the transformer line.

Fig. 4

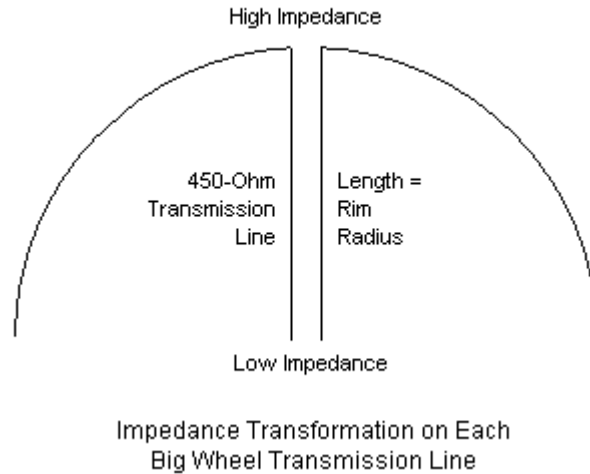

The original big wheel used an interesting combination of variables to perfect the practical shape of the assembly. **Fig. 5** points to some of them. The first item to notice is that with $\frac{1}{4}\lambda$ legs from the hub to the perimeter and each loop having a 1λ circumference (even though not a true circle), the circumference of the outer virtual circle will not be exactly $2\pi R$, where R is the radius along any of the 3 dotted lines.

Fig. 5

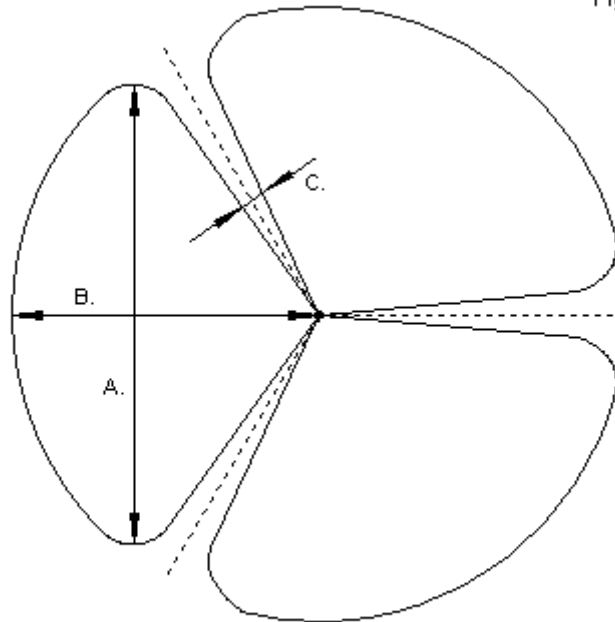

Some Construction Variables in the Original Big Wheel

The legs, as indicated by dimension C., form transmission lines with a variable spacing, therefore showing a different characteristic impedance at each end of the legs. Moreover, since

the original 3/8"-diameter tubing required a radius bend to prevent crimping, the transition from a transmission-line function to a radiating element function is dependent upon the radius or the rate of flaring.

The dimensions A. and B. show two ways in which one may vary both the impedance of the transmission-lines (legs) and the circumference of the circle at the same time. Stretching B. or compressing A. will pull the legs farther apart—and vice versa. Within much smaller limits, clamping dimension C. and then adjusting A. or B. will change the effective radius of the circle. In most cases, judicious warping of the initial shape would result in an impedance that one might use with a stub or beta match. Of course, such warping may have significant affects upon the ultimate pattern far-field pattern shape of the final version of the antenna. Essentially, the original big wheel employed mechanical methods to alter the electrical properties of the antenna element and the transmission lines (legs).

Most of the warping techniques are not available to us if we attempt to build a version of the big wheel that uses a perfectly circular rim and standard transmission lines as the means of converting the high-impedance rim feedpoint values down to a value that is compatible with coaxial cable. Extensive testing by Bob Cerreto, WA1FXT, on test versions of the revised big wheel yielded unacceptable impedance values at the hub. In fact, Bob tested two forms of the hub junction. One was the standard parallel connection shown in **Fig. 2**, using parallel transmission lines and a series Regier matching system. **Fig. 6** shows an alternative feed system in which we connect the lines in series. If the individual lines and rim sections are carefully constructed, the current division among the lines will be equal and the performance of the wheel will be identical to the values developed with a parallel feed system. (We shall return to the series feed system before we conclude.) The measured values were in fact just about 9 times the values shown by the parallel connection, with an unfavorable balance of reactance to resistance. A high X:R ratio generally means very sharp tuning using whatever adjustments may be available. Of course, mechanical tuning adjustments are just what the revised view of the big wheel lacks.

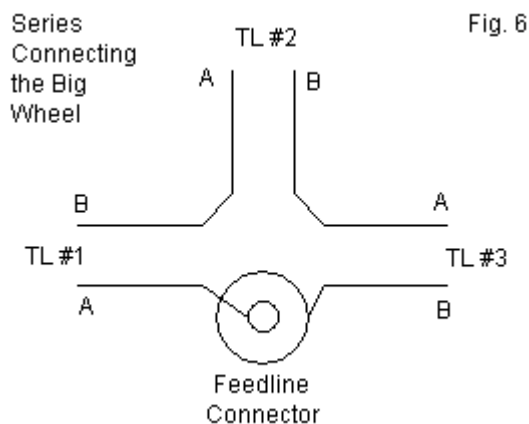

NEC modeling of the revised big wheel is sufficient to show the general concept of the antenna and its feed system, but it cannot provide any of the necessary guidance to sizing the assembly in its high-impedance rim-junction form. The transmission-line facility within NEC provides the most accurate results (relative to a physical implementation of the design) when applied to low-impedance regions of the antenna geometry. Ideally, the current on the segments adjacent to the segment that forms the terminal for one end of the transmission line

should be equal. In low-impedance regions of most antennas, the current changes very slowly from one segment to the next, allowing the effective use of modeled transmission lines for some distance from the segment with the very highest current. However, the accuracy of the results when installing NEC transmission lines in very low current regions of an antenna's geometry becomes dubious. Evidence of this fact emerges by changing the length of segments in the region of the line's termination. Small segment length changes yield very significant changes in the hub-end impedance.

As a consequence, modeling data gathered from the revised version of the big wheel serves only to show very general trends, but does not form the basis for a detailed analysis of the antenna's operation under varying conditions, such as changes in the rim radius or changes in the characteristic impedance and velocity factor of the line. In fact, most of the initial modeling data related to hub impedance proved to be at significant variance with the experimental data measured for the initial physical versions of the antenna.

Re-Designing the Big Wheel

Is there a way to tame the big wheel, that is, to create conditions that would ease the task of mechanically or electrically adjusting it, without losing its performance? The key to answering this question affirmatively lies in re-designing the antenna so that it exhibits a relatively low impedance at each of the rim feedpoints. Under these conditions, the models would benefit, since we may add NEC transmission lines with confidence in their accurate calculation of effects. As well, the physical implementation of the antenna would benefit by being far less sensitive to small variations in the structure of either the rim or the lines connecting the rim to the hub or central feedpoint.

To achieve these goals, let's consider each of the three sections of the original design as independent dipoles, each one curved so that the entire set forms a circle. Between each dipole and its adjacent mate, we shall leave a gap. We shall set the feedpoints at the center of each dipole in the circle. If we size the assembly correctly, we shall obtain the current magnitude distribution curves shown on the right in **Fig. 7**. The comparable current curves for the original big wheel appear on the left in the figure.

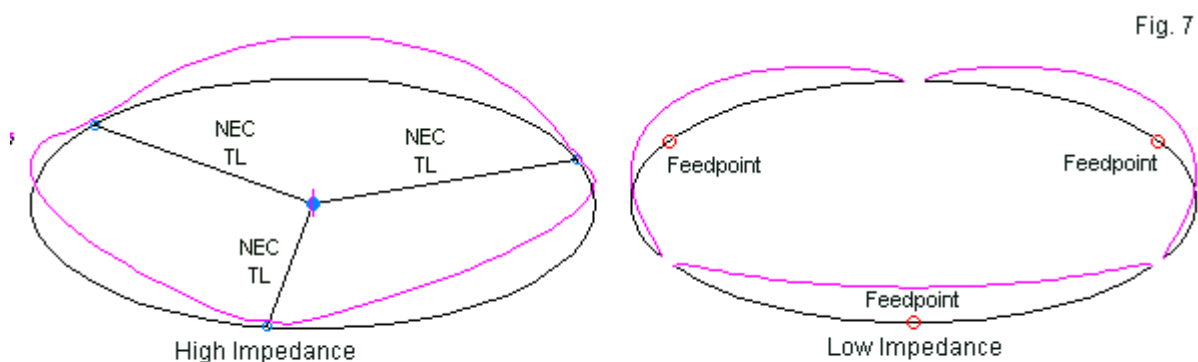

Re-Designing the Big Wheel for Low-Impedance Rim Feedpoints

The two antennas are alike in that both show three current peaks. However, the current on the new versions is maximum at the feedpoints on each dipole. Physically, the rim now has six equal-length element sections, since there are gaps between dipole ends and gaps at the

feedpoint of each dipole. We shall add the cabling harness further on. For the moment, the key question is whether the revised design achieves the same performance as the original big wheel.

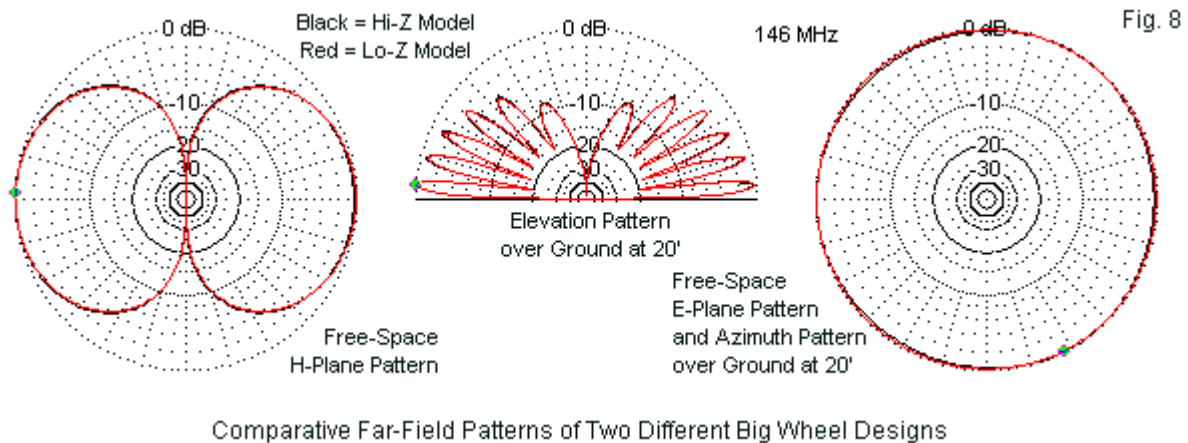

Fig. 8 overlays the free-space and over-ground patterns for the two designs. Whether in free space or 20' above average ground, the performance levels are indistinguishable. The three curved dipoles together yield an omni-directional horizontally polarized pattern that is within 0.1-dB of the original version patterns at every point.

The curved dipoles also show another benefit. Consider a simple $\frac{1}{2}\lambda$ dipole and a version of the antenna formed into a shallow V. The v-shaped dipole will show a lower impedance than the straight dipole. Depending upon the degree to which the V antenna departs from the dipole's linearity, the anticipated V feedpoint impedance might range from 45 to 55 Ω . The curved dipoles in the re-designed big wheel show the same effect on the feedpoint impedance. By correctly sizing the circle, we can obtain individual dipole feedpoint impedance values very close to 50 Ω .

If the rim element diameter is 0.5", then the radius of the circle must be about 15.5" to obtain dipoles that are resonant close to 50 Ω . The circle's total circumference is 97.4", of which 3" represent the total of the 3 gaps between dipole ends. The remaining 94.4" represents the total length of all 3 elements, or 31.5" per dipole. These dipoles are well under a half-wavelength at 146 MHz, in part because the dipole ends are closely coupled, despite the 1" gap between them. In fact, the gap represents a convenient adjustment factor, since varying this dimension in small, controlled steps has an impact on the feedpoint impedance. With the values shown, basic models of the antenna show an impedance at each feedpoint of 48.9 – j1.9 Ω .

Reducing the element diameter will require a larger circle. 0.375"-diameter dipoles require a radius of 16", with suitable adjustments in all of the other dimensions, except for the dipole end gaps, which remain at 1". Models using the thinner material and the right size rim show feedpoint impedance values of 53.5 + j2.0 Ω . For both materials, the feedpoint gap is part of the total dipole length and should be as small as is feasible.

Because each dipole feedpoint shows an impedance close to 50 Ω , we may use 50- Ω coax as the individual dipole transmission line to the hub junction. Since the dipole feedpoint impedance and the characteristic impedance of the line are closely matched, very little impedance transformation will occur, regardless of the velocity factor (and therefore the

electrical length) of the line chosen. At the hub, I tend to prefer a series connection, as suggested by **Fig. 9**. In that sketch, the solid and dashed lines represent the center conductor and the braid, respectively. In the series of lines, the braid of one dipole line connects to the center conductor of the next dipole's line.

Fig. 9

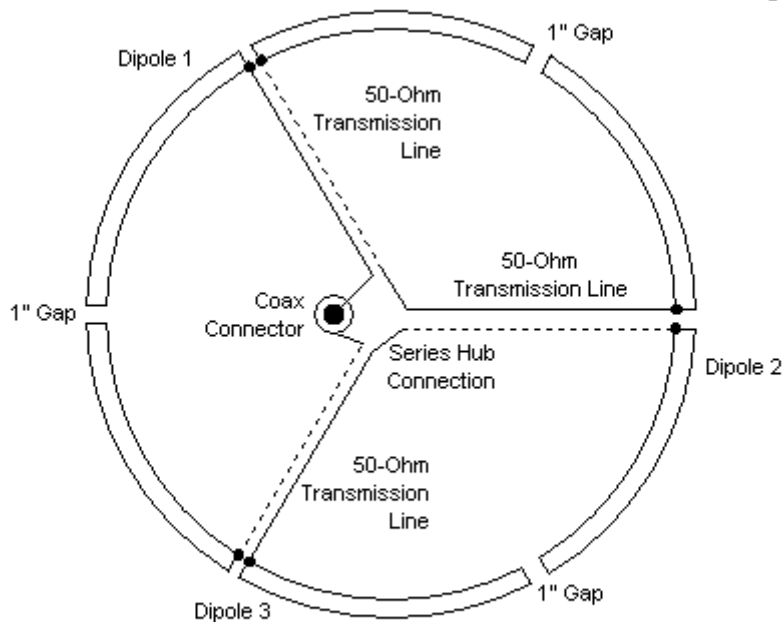

General Scheme of the New Big Wheel Connections

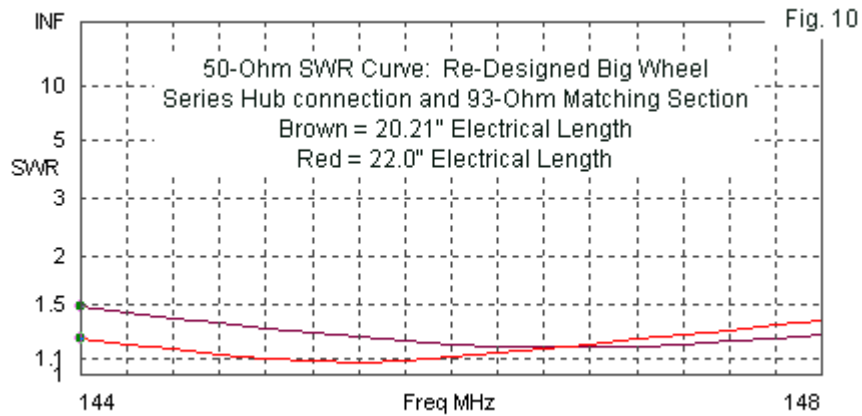

Fig. 10

The total series resistance will be approximately 150 Ω with about 20 Ω of inductive reactance, since the line matches are not perfect, but only close. However, the 7.5:1 ratio of resistance to reactance creates no problems for a standard $\frac{1}{4}$ - λ matching section. For example, a 93- Ω transmission-line section (RG-62) will yield a 55-56- Ω final impedance at 146 MHz. **Fig. 10** shows the anticipated SWR curve, which can be modified by judiciously lengthening or shortening the impedance transformation section. The brown line shows the curve with an exact electrical length of $\frac{1}{4}$ - λ at 146 MHz. The red line shows the curve displaced lower in the

band by increasing the line to a 22" electrical length. The gain and far-field pattern shape for the antenna do not change across the entire 2-meter band.

Constructing the re-designed big wheel is subject to as many variations as there are home shop skills and local materials. Therefore, **Fig. 11** represents only the scantiest of outlines of the basic needs for supporting the rim and the entire wheel. The sketch shows the support arms as darker lines. The non-conductive arms extend to the rim at the dipole ends. A T-fixture extends into the dipole ends both to support the elements and to provide some room for adjustment of the gap. The gap is useful for making small changes in the dipole impedance by changing the coupling between adjacent dipoles. Only if the individual feedpoint impedance of a dipole is well off the 50- Ω mark will the builder need to consider changing the array radius and the resulting length of each dipole. Of course, the feedpoint gaps will also require non-conductive inserts to set the gap and support both halves of each element.

Fig. 11

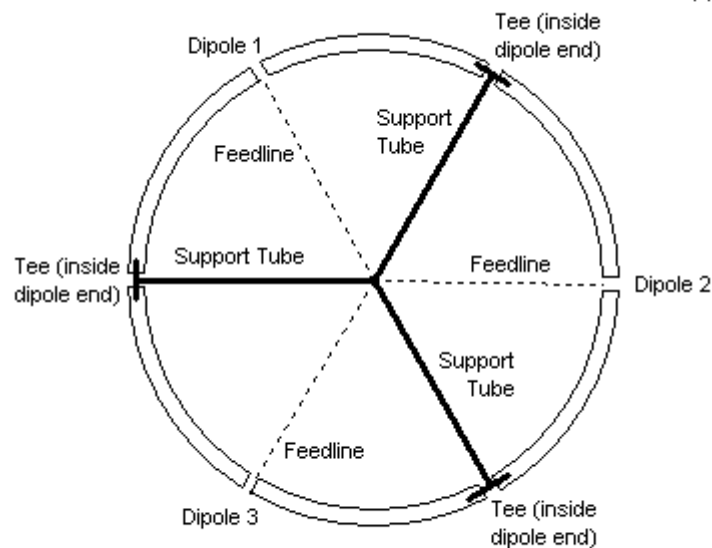

Basic Ideas for Supporting the Re-Designed Big Wheel

With a gain of about 7.25 dBi at 20' above average ground, the big wheel in any form provides excellent omni-directional coverage. The re-designed version of the antenna provides a slightly more compact physical circle than the original wheel. More significantly, it presents the builder with fewer challenges in obtaining the desired performance by easing the matching situation. The use of low-impedance dipole feedpoints allows the use of common materials in a relatively broadband situation. Simplification is usually a good sign of design improvement.

Tests

Bob Cerreto, WA1FXT, has constructed a 3-dipole wheel, with slightly modified dimensions to center the frequency between 144.5 and 135 MHz. Using 1/2" tubing, his wheel showed a hub sum impedance of close to 120 Ω with 18" RG-58 connecting cables from the hub to the rim. Therefore, he used a 1/4- λ section of RG-59 75- Ω cable as the matching section. In the process of adjusting the wheel, he used the gap between dipole ends as a means of varying the impedance values of the individual dipoles to arrive at virtually zero reactance at the hub on his design frequency. The new AIM impedance-measuring instrument aided Bob's tests.

Bob is a careful craftsman and would not minimize the effort necessary to build a 3-dipole wheel. Nevertheless, the process of construction plus adjustment is far simpler using 3 dipoles rather than the structure of the original 1961 big wheel.

Stacking Big Wheels

One popular configuration for big-wheel antennas is a vertical stack of 2. Because we may be tempted to misapply some rules of thumb derived from other antenna types, we should devote a small space to this topic before we close.

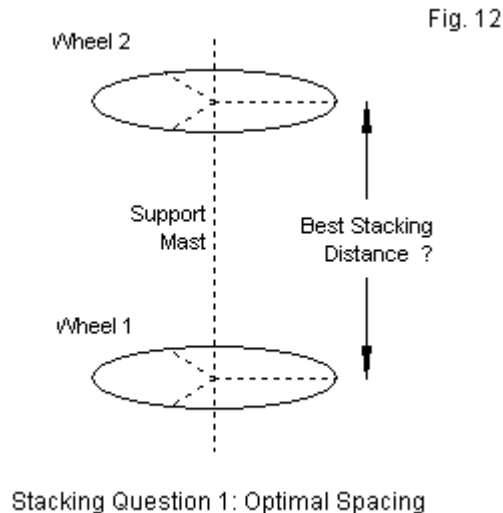
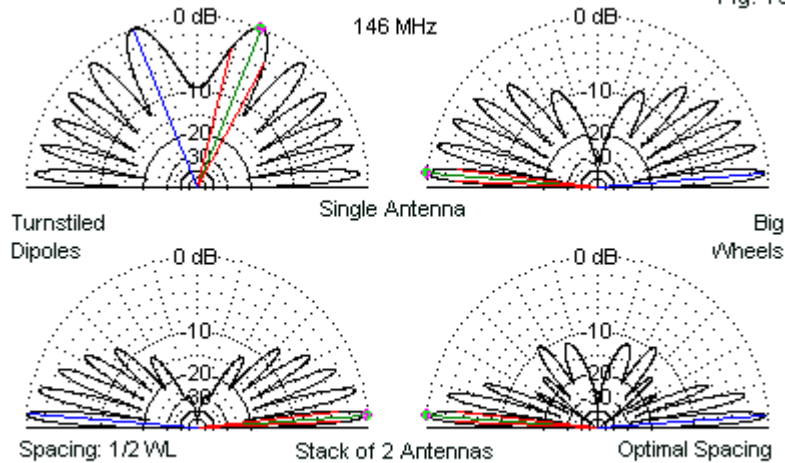

Fig. 12 shows the initial question. Like horizontal dipoles, the horizontally polarized big wheel increases gain when we stack two such antennas an optimal distance apart and feed the two antennas in phase. At the design frequency, 146 MHz, a wavelength is about 80.8", which makes stacking fairly convenient.

We need to know what separation distance is optimal for the big wheel. One popular separation is a half wavelength. The temptation to use this value arises from and is applicable to special circumstances. On the left, in **Fig. 13**, we find the elevation patterns of a single pair of turnstiled dipoles. Because radiation is stronger at high elevation angles, the use of $\frac{1}{2}\lambda$ spacing in a stack of 2 pairs of turnstiled dipoles is very productive.

The use of $\frac{1}{2}\lambda$ spacing with horizontal antennas tends to attenuate very high angle radiation and to make the energy available at lower angles. The maximum gain of a single turnstile pair is less than 5 dBi (with a 20' height above average ground) in the lowest lobe. With $\frac{1}{2}\lambda$ spacing, the lowest lobe shows better than 9-dBi gain when the lower turnstile is at 20' over the same type of ground.

Fig. 13



When 1/2-WL Stack Spacing is Optimal and When It is Not

On the right in the same figure, we have elevation patterns for the 3-spoke big wheel. The single antenna pattern uses a 20' height. However, by nature, the big wheel configuration does not show very high-angle energy levels. In fact, the lowest lobe has a gain of about 7.25 dBi. Therefore, the automatic use of a stacking space of $\frac{1}{2}\lambda$ is not necessary, and we are free to seek out the separation that yields maximum gain in the stack's lowest lobe, as pictured in the lower right elevation plot. **Table 1** provides modeled data for various stacking distances when the height of the lower 3-spoke big wheel is 20' above average ground.

Table 1. Performance of 3-spoke big wheels in a stack of 2 with the lower antenna 20' (240") above average ground.

Stack Spacing Inches	λ	Max. Gain dBi	TO Angle degrees	Feed Z (x2) R +/- jX Ω
40.4	0.5	9.17	4.4	64.7 - j22.5
50.5	0.625	9.99	4.3	54.5 - j19.4
60.6	0.75	10.50	4.2	49.4 - j13.7
70.7	0.875	10.64*	4.1	48.9 - j7.9
80.8	1.0	10.47	4.0	51.5 - j4.2

Note: Feed Impedance values based on the use of the single-antenna $\frac{1}{4}\lambda$ 93- Ω match described for single 3-spoke big-wheel antennas.

Gain honors go to a stack spacing of $\frac{7}{8}\lambda$, and the elevation plot in **Fig. 13** uses this value. However, stacking distances between $\frac{3}{4}\lambda$ and 1λ would not show any detectable differences in performance. Noticeable in the table is the fact that the two antennas interact so that the impedance values shift with each change in stacking height. Obtaining an impedance value closer to 50 Ω require at the ultimate feedpoint might require changes in the 93- Ω match section length at some separation distances.

The 3-spoke big wheel exhibited virtually no fluctuation in the gain around the perimeter. However, construction variations may create very small distortions in the pattern. The variations remain in an aligned stack of 2 such antennas at any stacking distance. One way to smooth the azimuth pattern is to orient the spokes at a 60° offset between the upper and the lower antennas. The offset technique will smooth the azimuth patterns of stacks having up to 1-dB or

greater fluctuations in gain around the horizon. However, it applies only to multi-element arrays in which the elements are fed in phase. Phased omni-directional assemblies, such as the typical turnstiled dipole pair, may increase pattern distortions when we offset the elements in a stack.

The second and final major question facing a big-wheel stacker is setting up the necessary cables to obtain in-phase feeding for the stack antennas. The re-designed big wheel with individual dipole impedance values close to 50 Ω gives us considerable flexibility in creating a stack. We shall note only two options among the many.

The first option is the most standard. It consists of two lengths of 75-Ω cable, each electrically $\frac{1}{4}\lambda$ long—or an odd multiple of $\frac{1}{4}\lambda$. The cables transform the 50-Ω Impedance at the transceiver end of the 93-Ω matching sections to 100 Ω. At the junction of these lines, the parallel connection results in an approximate 50-Ω main feedline impedance match. **Fig. 14** shows the general outline of this relatively standard phasing system—along with some of its limitations.

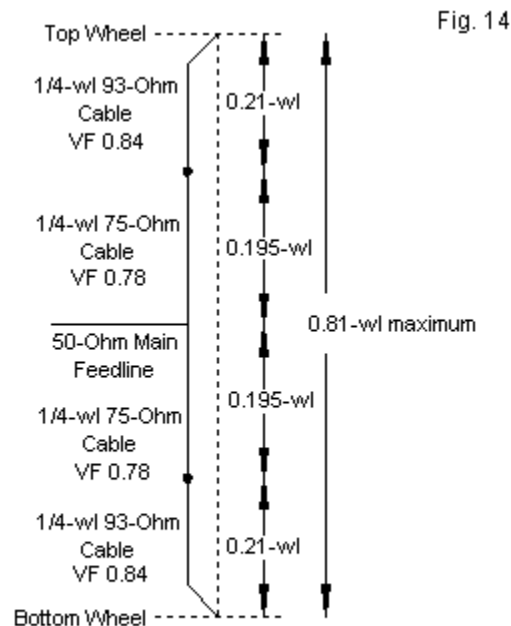

The "Standard" Phasing System

The key limitation lies in the maximum spacing distance that we may use: about 0.81λ . RG-62 has a velocity factor of 0.84, and some versions of RG-59 have a velocity factor of 0.78. These values reduce the physical length of each $\frac{1}{4}\lambda$ section, resulting in the maximum spacing distance if we do not resort to using $\frac{3}{4}\lambda$ sections for the phasing lines. Fortunately, 0.81λ is very close to the optimal spacing for the separation of the wheels in a 2-stack.

Fig. 15

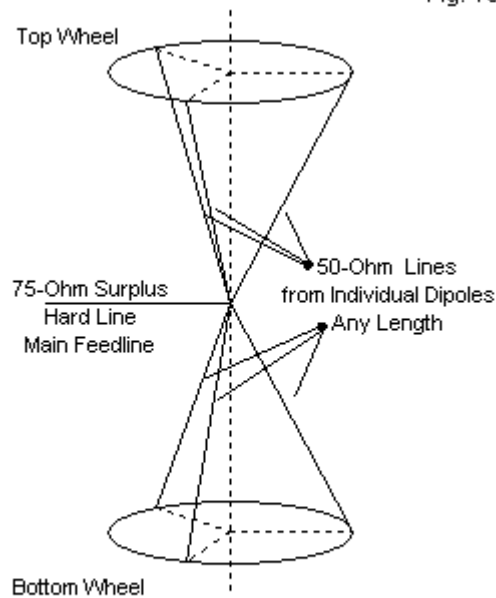

A Non-Standard Possible Phasing System
for Use with a 75-Ohm Main Feedline

Fig. 15 shows a second variation that is especially apt for installation in which 75-Ω surplus hard-line may be the main feedline. The scheme also illustrates some of the flexibility available in the re-designed big wheel. Since each dipole has close to a 50-Ω impedance, the length of the individual feedlines is not important. If we make the lines long enough to join in a series connection in the region of the stack junction, each line will still show about 50 Ω, resulting in a series sum impedance of about 150 Ω. If we connect each 150-Ω impedance in parallel, we obtain the desired 75-Ω impedance for the hard-line. It is also possible to use the sketch as a potential plan for the support system that holds each wheel in place and provides a set of non-conductive rods to which we may tape the cables.

Numerous other variations are feasible, both for creating and for supporting a stack of re-designed big wheels. In this arena, ingenuity shares a place with good electrical design.

Conclusion

An initial curiosity about the original 1961 big wheel led to questions about its fundamental operation and how to model it correctly. These questions revealed that the use of high-impedance rim-point attachments limited the builder's flexibility both in constructing and adjusting the antenna for reliable operation. A re-design of the antenna that separated the rim elements into three curved dipoles resulted in a wheel having all of the operational potential of the original wheel, but with much greater ease of reproduction and adjustment. Indeed, as the stacking exercise showed, the use of low-impedance dipoles allows the builder's ingenuity to evolve numerous variations on the design, all with full band coverage, omni-directional patterns, and very good gain for an antenna of its type. Acquiring a proper view of the antenna and then re-designing it does not really re-invent the big wheel, but it does make an interesting design more accessible to the home antenna builder.

Why Not a Triangle of Dipoles?

In the Mellon-Milner 1961 “Big Wheel” article in *QST*, the authors mention promising results from a triangle of dipoles in their quest for a horizontally polarized omni-directional antenna. They abandoned this direction of effort due to difficulties they encountered in matching the triangle to a standard coaxial cable feedline. It appears that the amateur community has also abandoned this approach to the desired goal. Let’s resurrect the triangle and see what we can do.

To create a triangle of dipoles, we may set up some criteria. First, we must position the three linear dipoles so that each one yields a feedpoint impedance of very close to $50\ \Omega$. Although we might use any practical material, let’s start with $\frac{1}{2}$ ”-diameter tubing. To set the positions, we may begin with a circle whose radius just touches the feedpoints of the individual dipoles. We shall use 146 MHz as the design frequency. Under these conditions, the required radius is about 15.4”

Due to proximity, each dipole interacts with its mates, resulting in a length that is considerably shorter than an independent dipole for the same frequency. The required length is 34.3” per dipole (including, of course, the feedpoint gap). With the specified radius of the feedpoint circle, the tips of adjacent triangles are 9.5” apart. **Fig. TR1** shows the general outline of the antenna, along with the relative current magnitude curves and an outline of the resulting far-field pattern.

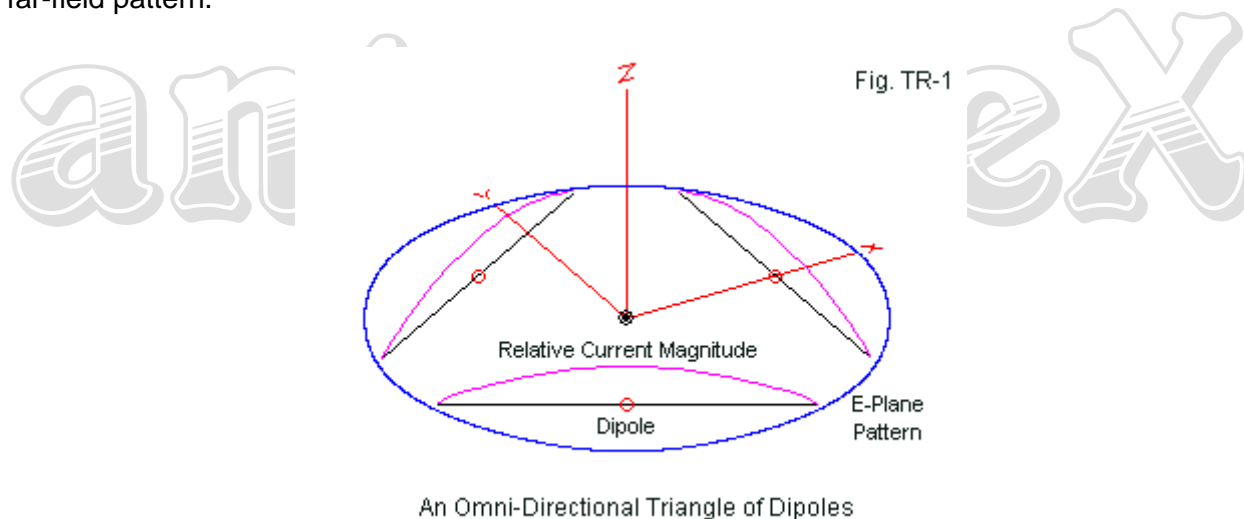

Although the pattern seems to be circular, we should examine more closely the free-space E-plane and H-plane patterns to confirm this appearance. **Fig. TR2** provides the data and overlays the patterns from the triangle of dipoles with the patterns for the wheel of dipoles having the same feedpoint impedance properties. The patterns coincide exactly. The triangle shows a maximum free-space gain of 1.46 dBi with a gain variation of only 0.26-dB around the 360° of the E-plane pattern. At 20’ above ground, the maximum gain is 7.25 dBi, again the same as the gain of the 3-dipole wheel.

Because we have roughly $50\text{-}\Omega$ resonant impedance values at the feedpoints of each dipole, we may also use the same series hub treatment that we gave to the wheel configuration. In series connection, the hub impedance will be close to $150\ \Omega$. With a $\frac{1}{4}\text{-}\lambda$ section of RG-62, $93\text{-}\Omega$ cable, the resulting impedance is close to $55\ \Omega$, with a very shallow SWR curve across the

entirety of 2-meters. Since the gain remains virtually constant across the band, we may use the antenna anywhere within 2 meters.

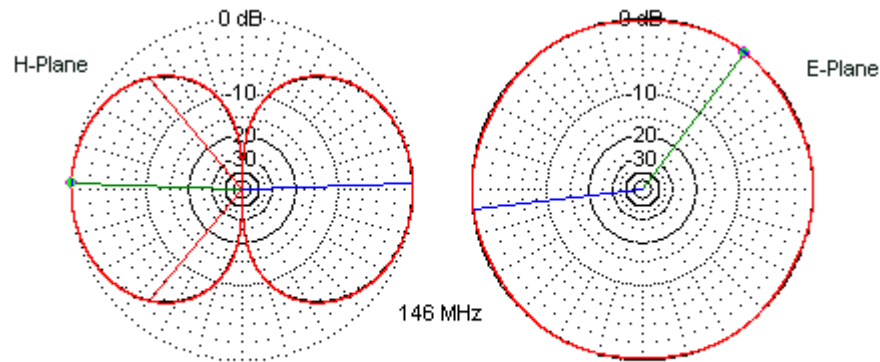
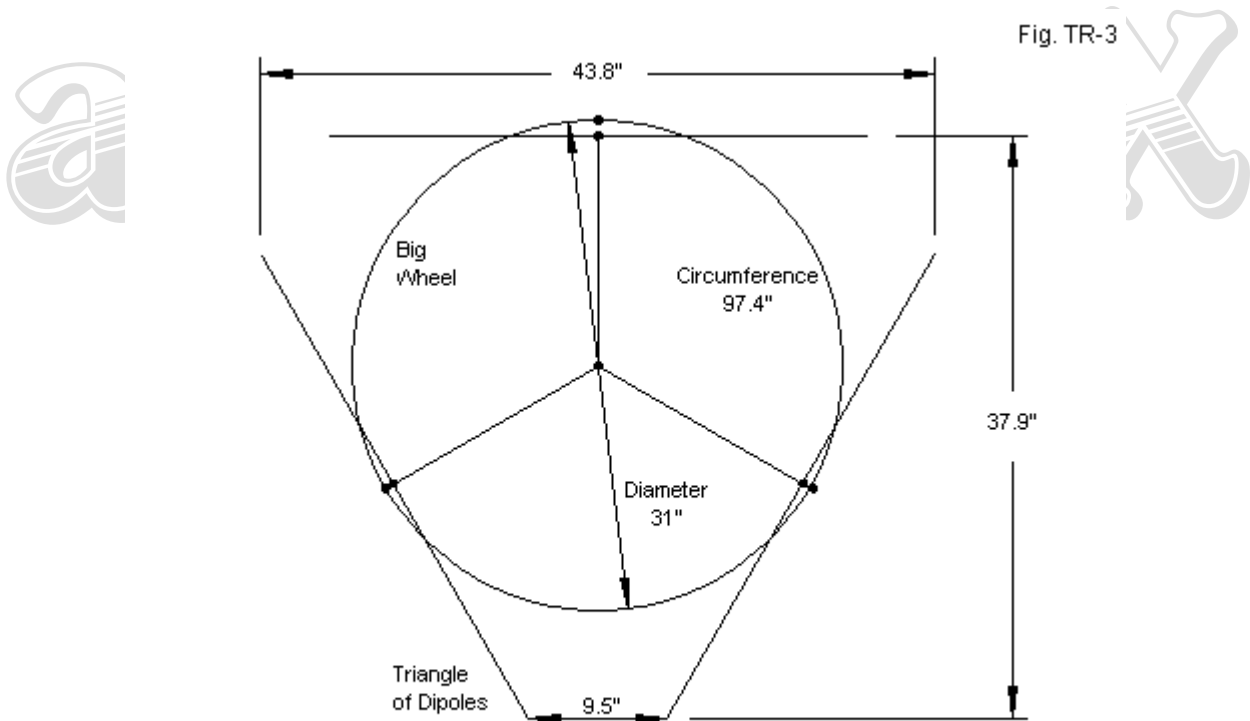

Fig. TR-2 Overlaid Free-Space Patterns for a Big Wheel and a Triangle of Dipoles

If a triangle of linear dipoles works identically to the dipole wheel, why use one or the other. The linear dipole triangle requires only three supports and involves no tube bending. However, **Fig. TR3** shows one reason for going to the trouble to form a wheel.



Comparative Areas Occupied by a Big Wheel and a Triangle of Dipoles Having the Same Performance

Although the triangle has a slightly smaller feedpoint radius than the wheel, it occupies more room. In practical situations, we must plan on clearing a rectangle of the size indicated in the sketch. The rectangle has twice the area required by the circle. In addition, the triangle results

in unsupported dipole ends. As a consequence, they are more susceptible to stresses created by local winds and weather. Finally, as noted to me by WA1FXT, there is an aesthetic difference between the two structures, a difference personified by Olive Oyl on the one hand, and Sophia Loren on the other.

Nevertheless, the dipole wheel and triangle are equivalent structures electrically. Hence, each provides the same horizontally polarized omni-directional service across 2 meters. For construction details on proto-type new big wheels in both triangular and circular configurations, see "A New Spin on the Big Wheel," with Bob Cerreto, WA1FXT, in *QST* for March, 2008 (pp. 30-34). In fact, these notes served as the theoretical background for the construction of the successful test antennas.

**© All Rights Reserved World Wide
ANTENNEX LLC**

antennex